

**GPS 50**  
**PERSONAL NAVIGATOR™**  
**OWNER'S MANUAL**

**GARMIN International, Inc.**

**GARMIN**

COMMUNICATION & NAVIGATION<sup>SM</sup>

**GPS 50**

**Personal Navigator™**

**OWNER'S MANUAL**

(for Software Version 2.0 or above)

© 1991-1992 GARMIN, 9875 Widmer Road, Lenexa, KS 66215

Printed in Taiwan.

All rights reserved. No part of this manual may be reproduced or transmitted in any form or by any means, electronic or mechanical, including photocopying and recording, for any purpose without the express written permission of GARMIN.

Information in this document is subject to change without notice. GARMIN reserves the right to change or improve their products and to make changes in the content without obligation to notify any person or organization of such changes or improvements.

October, 1992

190-00015-01 Rev. B

## PREFACE

GARMIN thanks you for selecting our high performance, full featured Personal Navigator™. The GPS 50 represents our continued commitment to provide you with a portable navigation unit that is versatile, extremely accurate, and easy to use. We are confident you will enjoy using your unit for many years to come.

The GPS 50's rugged construction and quality components offer the reliability demanded by the harshest operating environments. It may be used in marine and land vehicles, as well as by hunters, hikers, and military forces. The unit may be operated portably using its own battery pack, or it may use a 5-40 volt DC external power source for fixed mounted applications. You can even use a 115- or 230-volt battery charger for planning trips at home.

This manual and accompanying quick reference card provide complete information on safely operating the GPS 50 to its full potential. Two exciting practice voyages have been planned for you to practice your navigation skills using the built-in simulator. Afterwards, try a trip of your own to realize the value of the GPS 50 as your Personal Navigator™. If you have any questions or comments, our Customer Support Department is eager to serve you. GARMIN is fully committed to your satisfaction as a customer.

GARMIN International, Inc.  
9875 Widmer Road  
Lenexa, KS 66215

## CAUTION

The GPS system is operated by the government of the United States which is solely responsible for its accuracy and maintenance. The system is under development and is subject to changes which could affect the accuracy and performance of all GPS equipment. Although the GPS 50 is a precision electronic NAVigation AID (NAVAID), any NAVAID can be misused or misinterpreted, and therefore become unsafe. Use the GPS 50 at your own risk. To reduce the risk, carefully review and understand all aspects of this Owner's Manual and thoroughly practice operation using the simulator mode prior to actual use. When in actual use, carefully compare indications from the GPS 50 to all available navigation sources including the information from other NAVAIDs, visual sightings, charts, etc. For safety, always resolve any discrepancies before continuing navigation.

**NOTE:** This device complies with Part 15 of the FCC Rules. Operation is subject to the following two conditions: (1) This device may not cause harmful interference, and (2) this device must accept any interference received, including interference that may cause undesired operation.

# TABLE OF CONTENTS

CHAPTER		PAGE
<b>BASIC FEATURES</b>		
<b>1</b>	<b>INTRODUCING THE GARMIN GPS 50</b>	1-1
	1.1 Capabilities	1-1
	1.2 Operations	1-2
<b>2</b>	<b>GETTING STARTED</b>	2-1
	2.1 Front Panel	2-1
	2.2 Banners	2-1
	2.3 Cursor and Fields	2-3
	2.4 Keypad Operation	2-3
	2.5 Entering Data	2-5
	2.6 Viewing Messages	2-5
	2.7 Operating Modes	2-6
<b>3</b>	<b>BASIC OPERATION</b>	3-1
	3.1 Power On	3-1
	3.2 Satellite Status	3-1
	3.3 Present Position	3-2
	3.4 AutoStore™	3-4
	3.5 CDI and Navigation Summary	3-4
	3.6 Waypoints	3-5
	3.7 Nearest Waypoints	3-7
	3.8 Navigate to a Waypoint	3-8
	3.9 Man Overboard	3-9
	3.10 Sample Trip	3-9
<b>4</b>	<b>UNIT CUSTOMIZATION</b>	4-1
	4.1 Setup Menu	4-1
	4.2 Operating Mode	4-2
	4.3 User Selectable Alarms	4-2
	4.4 Backlighting Timeout	4-3
	4.5 Audio Settings	4-4
	4.6 Navigation Units	4-4
	4.7 CDI Scale	4-5
	4.8 Magnetic Variation	4-5

4.9	Filter Settings	4-6
4.10	Output	4-7
4.11	Map Datum	4-7

## **ADVANCED FEATURES**

<b>5</b>	<b>NAVIGATION PLANNING</b>	<b>5-1</b>
5.1	Navigation Menu	5-1
5.2	Date and Time	5-1
5.3	Event Timer	5-2
5.4	Trip Planning	5-4
5.5	Sunrise/Sunset	5-4
5.6	Alarm Clock	5-5
<b>6</b>	<b>ROUTES</b>	<b>6-1</b>
6.1	Navigating Using Routes	6-1
6.2	Route Catalog	6-2
6.3	Editing Routes	6-3
6.4	Activating Routes	6-5
6.5	Building Routes Using AutoStore™	6-7
<b>7</b>	<b>SAMPLE SIMULATED TRIP</b>	<b>7-1</b>

## **APPENDICES**

<b>A</b>	<b>MESSAGES</b>	<b>A-1</b>
<b>B</b>	<b>NAVIGATION TERMS</b>	<b>B-1</b>
B.1	Definitions	B-1
B.2	Course To Steer (CTS)	B-3
<b>C</b>	<b>INSTALLATION AND MAINTENANCE</b>	<b>C-1</b>
C.1	Specifications	C-1
C.2	Electrical Wiring	C-3
C.3	Universal Mount Installation	C-4
C.4	Universal Mount Operation	C-7
C.5	Battery Pack Operation	C-9
C.6	Maintenance	C-10
C.7	Customer Support	C-11
<b>D</b>	<b>MAP DATUMS</b>	<b>D-1</b>
<b>E</b>	<b>INDEX</b>	<b>E-1</b>

# CHAPTER 1

## INTRODUCING THE GARMIN GPS 50

### 1.1 CAPABILITIES

The GPS 50 provides a host of powerful capabilities which were previously found only in much larger systems:

- **Performance:** State-of-the-art MultiTrac™ receiver tracks up to eight satellites while providing high receiver sensitivity, fast first fix, and continuous navigation updates.
- **Portability:** Goes where you go - on sea or land. The built-in simulator allows you to plan your next trip or hone your navigation skills at home or in your office.
- **Navigation:** Illuminated keypad and display provide the navigation information you need at a glance. Store up to 250 alphanumeric waypoints and 10 reversible routes. The GOTO function sets an instantaneous course to the waypoint of your choice. The AutoStore™ function helps you build routes as you go. A flashing Message Annunciator and an audible message tone keep you fully informed of your navigation status.
- **Personalized:** Configure your unit the way you like by selecting nautical units, Course Deviation Indicator (CDI) sensitivity, keypad and display features, map datums, and interface options.
- **Low Power Consumption:** Battery Saver operation, which draws less than 1.1 watts, provides up to ten hours of continuous operation with four AA size alkaline batteries.
- **Man Overboard:** The Man Overboard function sets an instantaneous course to the captured position, providing rapid response to an emergency situation.
- **Trip Planning:** Analyze distance and time requirements for your trip. Compute the time of sunrise and sunset at your destination.
- **Alarms:** An alarm clock and timer allow the GPS 50 to watch the clock for you. Arrival, anchor drag, and CDI alerts help you safely navigate your craft.
- **Interfaces:** Interface with marine autopilots and graphical plotters.



We encourage you to read through this manual and experiment using the built-in simulator. This will help you quickly master the power of the GPS 50.

## **1.2 OPERATIONS**

You may use your GPS 50 for both portable and fixed operations. The unit may be operated from external AC power using a battery charger, external 5-40 volt DC power using the power/data cable or cigarette lighter adapter, or using a battery pack.

### ***Handheld Operation:***

For handheld operation, the GPS 50 is powered by a AA battery pack which should be filled with four high quality alkaline batteries commonly found at retail stores. A rechargeable nicad battery pack is also available for handheld operation.

In order to track GPS satellites, the unit must be situated with the antenna pointed straight up and should not be blocked by objects or people (signal reception through thin fabric such as canvas may be adequate but degraded). A lanyard is provided to prevent accidental dropping of your GPS 50. (Connect the lanyard to the eyelet on the back of the unit.)

### ***Fixed Mount Operation:***

A universal mount is supplied for swivel or surface mount installation in a boat. The unit may be operated using vehicle power through the power/data cable or it may be operated using the battery pack. While using vehicle power, you may wish to leave the battery pack in the unit. In the event of vehicle power failure, the GPS 50 will automatically switch to battery power.

In addition to supplying power to the unit, the power/data cable allows you to interface your GPS 50 with other marine electronic devices such as plotters or autopilots.

A Marine/RV Remote Antenna is available for installations which require an external antenna for an unobstructed view of the sky. This weather-proof antenna includes 30 feet of low-loss antenna cable. The remote antenna has been constructed to thread onto a standard 1" antenna mount. Antenna mounts, commonly used to attach VHF radio antennas and Loran-C couplers, are readily available from your local marine accessories dealer.

A Magnetic Mount Antenna is also available for attaching a remote antenna to a metallic surface. This weather-proof antenna includes 10 feet of low-loss antenna cable. A cigarette lighter adapter cable may be used to power the unit in vehicle applications.

# CHAPTER 2

## GETTING STARTED

### 2.1 FRONT PANEL



The front panel consists of a 20-key keypad and a LCD display which includes three lines of information and various banners. Both the display and keypad are illuminated for operating in darkness.

### 2.2 BANNERS

Information displayed on the LCD is commonly referred to as a "page". A page consists of alphanumeric information and banners. Banners, illustrated below, are used to indicate the type of page, navigation units, and data displayed (see Appendix B). They also indicate navigation fix type, satellite tracking, and provide user prompting.

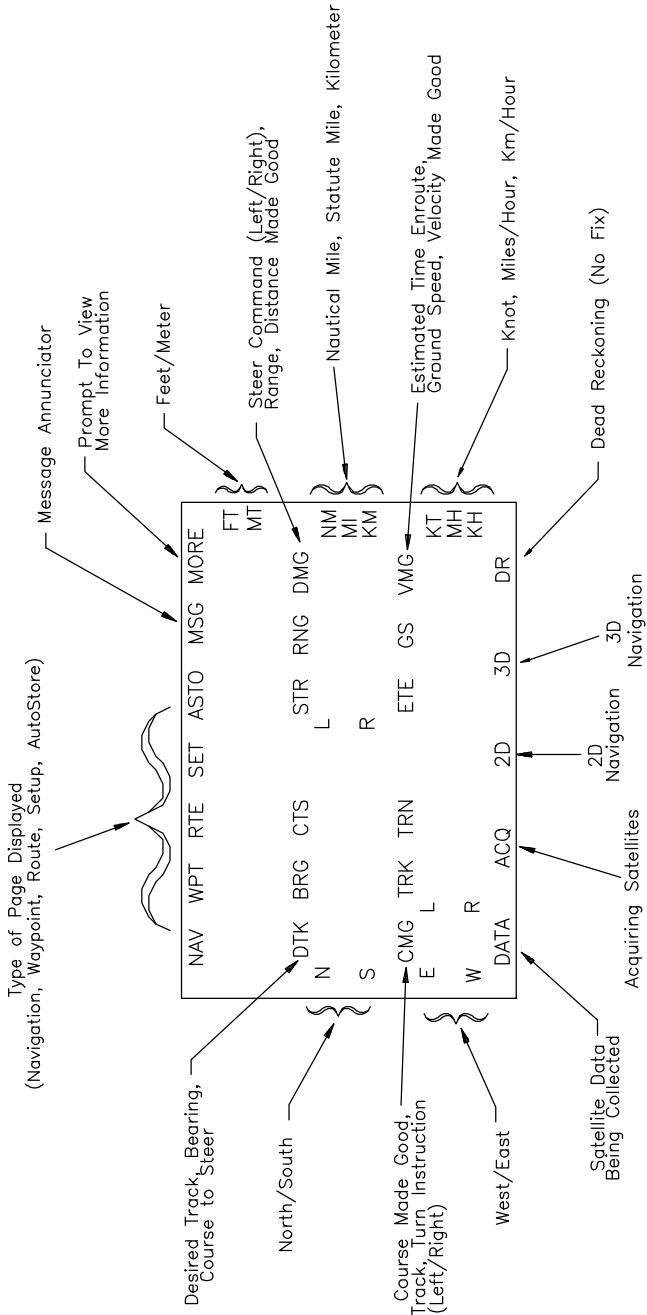

## 2.3 CURSOR AND FIELDS

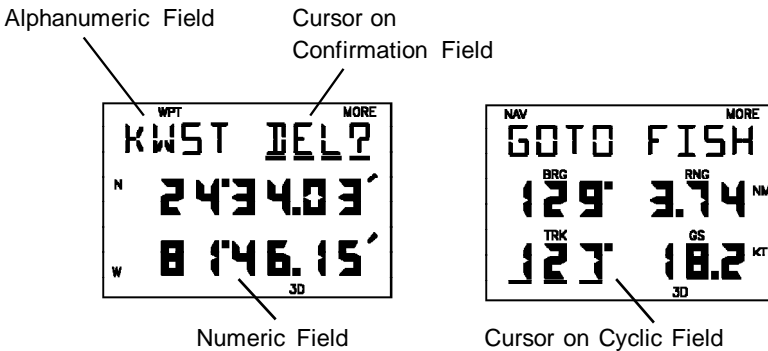

The area of the page which is underlined is called the **cursor**. The cursor may be moved to locations on the page called **fields** which allow you to enter data. You will encounter four types of fields.

- **Numeric fields** accept numbers. For example, you will enter a waypoint's latitude in a numeric field.
- **Alphanumeric fields** accept numbers as well as letters. For example, you will enter a waypoint's name in an alphanumeric field.
- **Cyclic fields** allow you to select from one of several available options. For example, you may select between DTK (desired track), BRG (bearing to waypoint), or CTS (course to steer) using a cyclic field. Cyclic fields are indicated on the display by the "MORE" banner.
- **Confirmation fields** allow you to indicate your approval. For example, you will be asked to confirm that you want to delete a waypoint. Confirmation fields always end with a "?" character.

## 2.4 KEYPAD OPERATION



The PWR/BRT key is a dual function key that controls unit power and panel backlighting.

When the unit is on, pressing the PWR/BRT key will turn on the panel backlighting. Pressing the PWR/BRT key again will turn off the backlighting.

To turn the unit off, press and hold the PWR/BRT key for three seconds until the display is blank.



Pressing the MSG/SET key allows you to view new messages when the "MSG" banner is flashing. (See Section 2.6 and Appendix A.) Pressing the MSG/SET key also selects the Setup Pages which allow you to view satellite tracking status and customize the unit as you like. (See Section 3.2 and Chapter 4.)



Pressing the GOTO/MOB key once allows you to initiate the GOTO function, which will set an instantaneous course to any waypoint. (See Section 3.8.) Pressing the GOTO/MOB key twice in succession allows you to initiate the Man Overboard function, which will set an instantaneous course to the captured position. (See Section 3.9.)



Pressing the NAV key selects the Navigation Pages which allow you to view navigation information and perform planning functions. (See Sections 3.3 and 3.5 and Chapter 5.)



Pressing the WPT key selects the Waypoint Pages which allow you to create, edit, delete, and rename waypoints. In addition, you may view your nearest waypoints. (See Sections 3.6 and 3.7.)



Pressing the RTE key selects the Route Pages which allow you to edit, review, activate, and delete routes. (See Chapter 6.)



Pressing either of the arrow keys allows you to move the cursor, scroll through information lists, and enter letters of the alphabet.



The alphanumeric keys allow you to enter letters and numbers into the GPS 50.

If you want to enter a number in a numeric field, for instance "1", simply press the 1 key. If you want to enter a letter in an alphanumeric field, for example "A", press the 1 key to display B, then press the left arrow key once to select "A" (you may also press the right arrow key three times to display the "A").



Pressing the CLR/MORE key erases information in the cursor field. If the cursor is over a cyclic field, pressing the CLR/MORE key will toggle through several available options.



Pressing the ENT key completes the process of data entry. If the cursor is over a confirmation field, pressing the ENT key indicates your approval.

## 2.5 ENTERING DATA

To enter data you must first move the cursor under the desired field by pressing the right or left arrow key.

### To enter a number...

- Press the key that is labeled with the desired number. The numbers will fill in from the left side of the field similar to a typewriter. You must enter any leading zeros in the field. For example, if you wish to enter "51" in a three space field, you must press the 0, 5, and 1 keys in that order.
- Press the CLR key if you enter an incorrect number.
- Press the ENT key when you have filled all significant digits of the field with numbers (trailing zeros are automatically filled in by the GPS 50).

### To enter a letter...

- Press the key that is labeled with the desired letter.
- Press the right or left arrow key until the desired letter is displayed.
- Press the CLR key if you enter an incorrect letter.
- Press the ENT key when all the characters are entered.

The GPS 50 features a keypad feedback tone which will sound each time you press a key. If you enter data which is not appropriate for the field, the feedback tone will quickly sound three times indicating an error. The keypad feedback tone can be turned off if you wish (see Section 4.5).

## 2.6 VIEWING MESSAGES

From time to time, the GPS 50 will use a message to tell you of conditions that need your attention. When the GPS 50 has a new message for you, the MSG banner will flash. When this occurs, press the MSG key to view new message(s). Continue to press the MSG key until the page you were viewing prior to pressing the MSG key is displayed.

While the MSG banner is flashing, the GPS 50 will also generate an audible tone to alert you of the message (if your unit is connected to an external alarm, it will also be activated). Messages that demand immediate attention such as an arrival alarm generate a quick tone that will not stop until you view the message. All other messages generate a slow tone that will cease after 15 seconds. The message tone may be turned off if you wish (see Section 4.5).

Important messages will remain on the Message Page after being viewed. If this occurs, the MSG banner will be in view but will not flash (if no messages exist, the MSG banner will not be visible). To review these messages, press the MSG key until the “MESSAGES” title is displayed. Then, press the MORE key until the “END MSGS” title is displayed.

Refer to Appendix A for a complete list of GPS 50 messages.

## 2.7 OPERATING MODES

Three modes are available which will allow you to operate your GPS 50 in the way which best suits your needs (see Section 4.2).

**Normal** mode is most suitable for high dynamics applications. The GPS 50 will typically operate up to six hours on a single pack of batteries.

**Battery Saver** mode is suitable for most applications and will extend the battery life to as much as ten hours.

**Simulator** mode allows you to simulate the operation of the GPS 50 while at home or in your office. The simulator mode can be used while learning to use your GPS 50 and is ideal for planning routes and entering waypoints. Keep in mind that the GPS 50 is not tracking satellites in the simulator mode. You should never attempt to use the simulator mode for actual navigation.

If you are using your GPS 50 for the first time, we encourage you to review Chapter 3 which introduces the GPS 50's basic features. Additionally, you may wish to review Chapter 4 on custom setups. Afterward, you may want to read through the rest of this manual and make further use of the built-in simulator to practice with the advanced features.

# CHAPTER 3

## BASIC OPERATION

### 3.1 POWER ON

After you turn your GPS 50 on, it will conduct a series of self tests and display the following notices: “VER x.xx”, “COPYRIGHT”, “1991-1992”, and “GARMIN”. Following completion of the tests, the GPS 50 will begin acquiring satellites that will typically take two minutes to obtain a position fix.

Initially, the GPS 50 will display the “ACQ” banner; it will inform you when a position fix is obtained by transitioning to either the “2D” or “3D” banner. When four or more satellites with good geometry are available, the GPS 50 will automatically operate in the 3D mode in which latitude, longitude, and altitude are computed. If only three satellites are available, the unit will operate in 2D mode in which only latitude and longitude are computed. When operating in the 2D mode, the unit will use the last computed altitude or your last entered altitude (Section 3.3 describes how you may enter the altitude). If less than three satellites with acceptable geometry are available, the “DR” banner will be displayed.

Your GPS 50 will automatically update satellite orbital data as it operates. If you have not operated your unit for a period of six months or longer, it will take approximately 12.5 minutes to search the sky and collect new orbital data. You will be informed when your unit is searching the sky with the message “SRCH SKY”. Additionally, the “DATA” banner will be displayed. Once satellite orbital data is collected, it will be stored in battery backed up memory. This means the data will not be lost when you turn your GPS 50 off.

### 3.2 SATELLITE STATUS

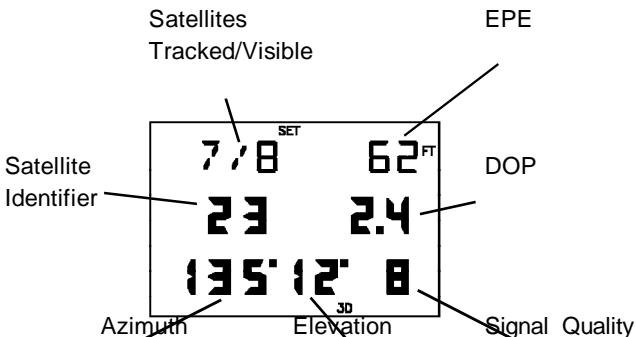

SATELLITE STATUS PAGE



The Satellite Status Page may be displayed by pressing the SET key. This page shows the number of satellites tracked and visible, dilution of precision (DOP), and estimated position error (EPE). DOP is a measure of the satellite geometry quality and hence the relative accuracy of your position (1 meaning the best and 10 meaning poor). EPE, which is computed using the satellite geometry (DOP), signal, and data quality, receiver tracking status and other factors, is an overall measure of your position accuracy. DOP and EPE are advisory information only.

The Satellite Status Page also shows the identifier (1-32), azimuth, elevation, and signal quality of up to eight visible satellites. The azimuth is an angle from 000° to 359° which indicates the bearing from the present position to the satellite, with 000° representing true north. The elevation is an angle from 00° to 90° which indicates the height of the satellite above the horizon, where 00° indicates the horizon and 90° indicates a satellite is directly overhead. The azimuth and elevation are useful for determining whether a satellite signal is blocked by buildings, mountains, or other obstructions. The signal quality is a number from 1 through 9, with 9 indicating the strongest signal. If a satellite is visible but not tracked, the signal quality will be blank.

The Satellite Status Page will automatically display each satellite's information for three seconds. You may also manually scroll through the list of visible satellites.

### To manually scroll through the visible satellite list...

- Use an arrow key to move the cursor under the satellite identifier.
- Press MORE to view each visible satellite's information.
- Press ENT to remove the cursor and return to automatic mode.

### 3.3 PRESENT POSITION

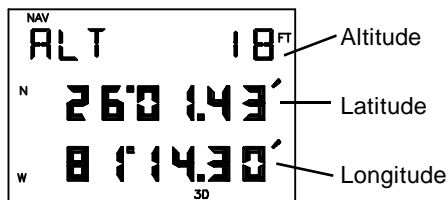

POSITION PAGE

The Position Page may be displayed by pressing the NAV key. This page displays your latitude and longitude relative to the selected earth datum (see Section 4.11), as well as the altitude above mean sea level (MSL).

When the GPS 50 is performing 2D navigation, the last known altitude will be used in the latitude/longitude computation. If the altitude is not accurate within a few hundred feet, you should manually enter your altitude.

### **To change the altitude...**

- Use an arrow key to move the cursor under the altitude.
- Enter the altitude. If your antenna is mounted on a high mast, make sure you add the mast height. (Remember to complete the data entry by pressing ENT.)

During initial satellite acquisition, the displayed position is the last computed position stored in the GPS 50. If your position has moved more than 1000 nautical miles with the power off, you may wish to enter a more accurate initial position to speed up the acquisition process. (You may also change the position at any time when you are operating in simulator mode.)

### **To change the latitude/longitude...**

- Use an arrow key to place the cursor under the latitude field.
- Check the hemispheric designation (“N” or “S”) of the latitude. If it is correct, go to the next step. If it is incorrect, press the CLR key until the correct hemispheric designation is displayed.
- Enter the latitude (remember to complete the data entry by pressing ENT).
- Check the hemispheric designation (“E” or “W”) of the longitude. If it is correct, go to the next step. If it is incorrect, press the CLR key until the correct hemispheric designation is displayed.
- Enter the longitude (remember to complete the data entry by pressing ENT).

### 3.4 AUTOSTORE

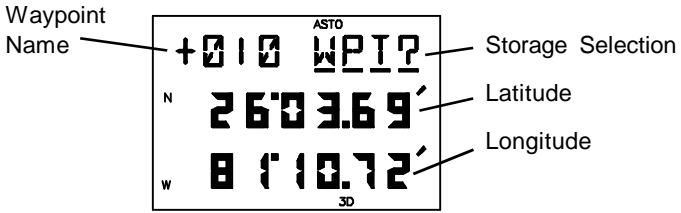

AUTOSTORE™ PAGE

The AutoStore™ Page is displayed by pressing the ENT key while viewing the Position Page. This page allows you to capture your position at the touch of a button so that you may easily return later. Additionally, you may record your navigation path by inserting the captured waypoints into a route (see Section 6.5).

#### To capture your present position...

- Press NAV until the Position Page is displayed.
- Press ENT. The AutoStore™ Page will be displayed with the default waypoint name on line one. The waypoint name begins with a “+” character followed by a 3-digit number, for example “+010”.
- If you wish to give the waypoint a name of your own, move the cursor under the waypoint name and enter the name of your choice.
- With the cursor under “WPT?” (the storage selection field), press ENT.

### 3.5 CDI AND NAVIGATION SUMMARY

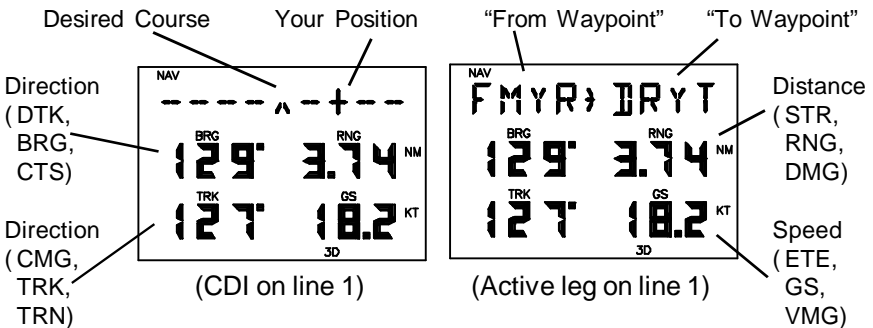

CDI PAGE

The CDI Page may be displayed by pressing the NAV key. This page displays virtually all the information you need to guide your craft.

The CDI (Course Deviation Indicator) is oriented so that the center represents your desired course and the CDI hash represents your position. You must steer toward the center of the CDI to eliminate cross track error and stay on course. The to/from arrow in the center of the CDI indicates if you are navigating to the waypoint (up arrow) or if you have passed the waypoint (down arrow). You may set the CDI alarm and CDI scale from the Setup Pages (see Sections 4.3 and 4.7).

You may select the type of information you wish to see on each line. To make a change, place the cursor under the field and press the MORE key until the appropriate information is displayed. (See Appendix B for an illustration and further explanation of the selectable navigation information on lines two and three.)

On line one, you may elect to display a CDI or the active leg (see Chapter 6).

On line two, you may select one of three direction options (desired track, bearing, or course to steer). You may also select one of three distance options (steer direction and distance, range, or distance made good).

On line three, you may select one of three direction options (course made good, track, or turn instruction). You may also select estimated time enroute or one of two velocity options (ground speed or velocity made good).

During the process of acquiring satellites, the GPS 50 will not provide navigation data. The CDI Page will indicate this condition by displaying "NO POSN" on line 1 and all navigation data on lines 2 and 3 will be blank. If the GPS 50 is not navigating to a waypoint, the CDI will indicate this condition by displaying "NO ACT WP" (no active waypoint) and all navigation data except speed and track will be blank.

### **3.6 WAYPOINTS**

The GPS 50 allows you to create, store, and use 250 alphanumeric waypoints. A waypoint consists of a name (up to four letters or numbers), and its latitude/longitude location. You will have the opportunity to use waypoints extensively while operating the GPS 50. For example, you can navigate to a waypoint, build a route using waypoints, and perform trip planning using waypoints.

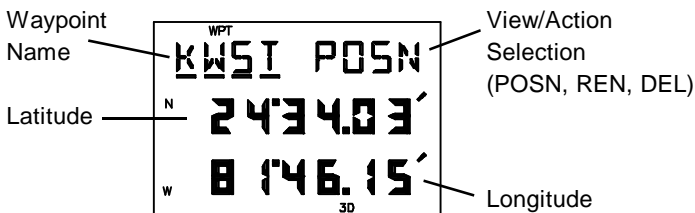

## WAYPOINT DEFINITION PAGE

The Waypoint Definition Page may be displayed by pressing the WPT key. It allows you to review, create, modify, delete, and rename waypoints.

### To create, modify, or review a waypoint

- With the cursor under the waypoint name field, enter the desired waypoint name. (Press the MORE key until "POSN" is displayed if it is not already displayed under the view/action field.)
- To create or modify position, enter the waypoint latitude and longitude as described in Section 3.3. (NOTE: If a waypoint is being used for navigation, its position cannot be modified. An attempt to modify the position of such a waypoint will result in the message "ACTV WPT".)

### To rename a waypoint...

- With the cursor under the waypoint name field, enter the name of the waypoint to be renamed.
- Press MORE until "REN?" is displayed.
- Press ENT, the following page will be displayed.

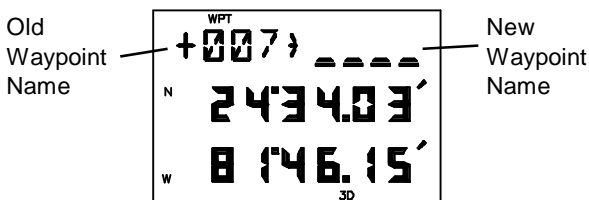

- Enter the new waypoint name.

### To delete a waypoint from memory...

- With the cursor under the waypoint name field, enter the name of the waypoint to be deleted.
- Press MORE until "DEL?" is displayed.

- Press ENT, the waypoint is now deleted from memory. (NOTE: If you wish to delete a waypoint that is used in a route, first remove it from all routes before attempting to delete the waypoint. An attempt to delete a waypoint used in a route will result in the message "ROUTE WPT".)

A stored waypoint is used by entering its alphanumeric name on a waypoint name field. (When a waypoint name which does not exist is entered, the error tone will sound.) As an alternative, the GPS 50 provides a scanning feature that allows you to select a waypoint by quickly scanning through the entire list of waypoints in alphabetical order (numbers are ordered before the letters of the alphabet).

### To select a waypoint by scanning...

- With the cursor under a waypoint name field, press WPT. The first alphanumeric waypoint will be displayed in the waypoint field. (Each time the Waypoint Definition Page is selected, the scanning mode will automatically be activated with the first alphanumeric waypoint displayed. There is no need to press WPT.)
- Use the arrow keys to scan through the entire list of waypoints.
- With the desired waypoint shown, press ENT to select the waypoint (press CLR to cancel the scanning operation at any time).

Variable rate scanning is implemented to allow you to quickly go through the list. When the arrow keys are pressed briefly, you step through the waypoints one at a time. As the arrow keys are held for a longer period of time, the waypoint list scrolls more rapidly; the longer the arrow keys are held, the larger the step through the list.

### 3.7 NEAREST WAYPOINTS

An important feature of the GPS 50 is the ability to display up to nine waypoints nearest to your position (but not further than 100 nautical miles). In an emergency, you may use the nearest waypoint feature to find the closest point of safety in your area.

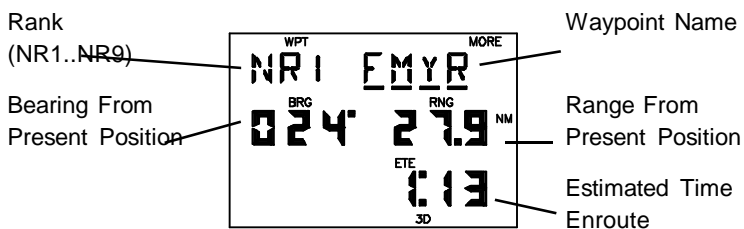

NEAREST WAYPOINT PAGE

The Nearest Waypoint Page may be displayed by pressing the WPT key. It provides the waypoint name and bearing/range/estimated time enroute from present position. Entire lists of your nearest waypoints (indicated by NR1 through NR9) may be viewed by pressing the MORE key while the cursor is under the waypoint name.

### 3.8 NAVIGATE TO A WAYPOINT

The GOTO function allows you to quickly set a course from your position to any waypoint.

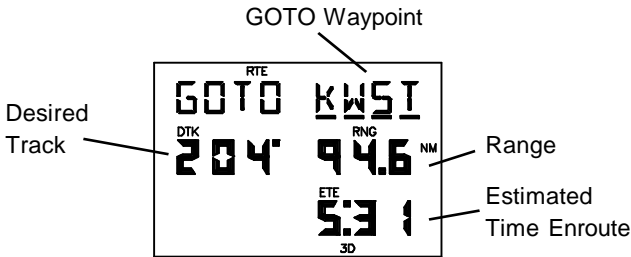

ACTIVE ROUTE PAGE (GOTO MODE)

#### To activate the GOTO function...

- Press GOTO. The Active Route Page will be displayed with the cursor under the GOTO waypoint field. If the GPS 50 is currently navigating to a waypoint, that waypoint will be offered as the default GOTO waypoint.
- Confirm the default GOTO waypoint by pressing the ENT key (this will re-center CDI on the CDI page) or enter the desired GOTO waypoint name. The CDI Page will be displayed.

Alternatively, the GOTO function may be quickly activated from any page (e.g. the Nearest Waypoint Page) by placing the cursor under the desired waypoint name and pressing the GOTO key. The Active Route Page will be displayed with the cursor under the GOTO waypoint name. The GOTO function will be activated when the ENT key is pressed.

#### To cancel the GOTO function...

- Press GOTO.
- Press CLR, the GOTO waypoint name will become blank.
- Press ENT. The GPS 50 will start to navigate using the active route, if it has been programmed (see Chapter 6). Otherwise, the GPS 50 will cease the computation of all waypoint navigation data.

### 3.9 MAN OVERBOARD

The Man Overboard function allows you to set an instantaneous course to a captured position, providing rapid response to an emergency situation.

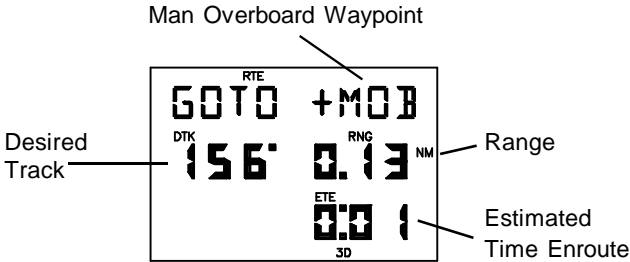

ACTIVE ROUTE PAGE (MAN OVERBOARD MODE)

#### To activate the Man Overboard function...

- Press MOB twice. The Active Route Page will be displayed and the present position will be captured in a waypoint named “+MOB”.
- Press ENT to navigate to the Man Overboard waypoint. The CDI Page with navigation information to “+MOB” will be displayed.

### 3.10 SAMPLE TRIP

Now that you have gained a basic understanding of the GPS 50, you are ready to embark on a sample trip! (The sample illustrations in this section assume that the factory default settings have not been changed. If you have changed these parameters, the unit may display slightly different data than presented here.)

Your GPS 50 is factory initialized with a position of N39°, W095°. A waypoint named GRMN, located at GARMIN’s Lenexa, Kansas facilities, is also provided (GARMIN is located 109°, 11.8 nautical miles from the initial position).

Just for fun, let’s go to GARMIN! Turn on your GPS 50. The power on notices will be displayed followed by the Satellite Status Page as illustrated below.

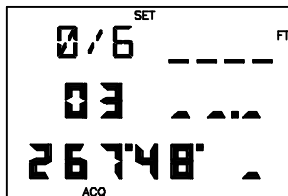



The GPS 50 is ready to accept your commands!

### Select the simulator mode...

- Press SET until the Set Menu is displayed.

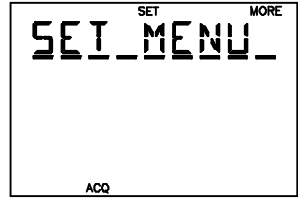

- Press MORE until "OP MODE?" is displayed.

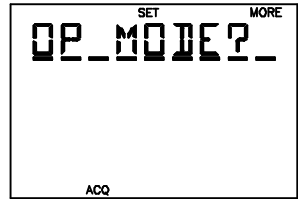

- Press ENT to display the Operating Mode Page.

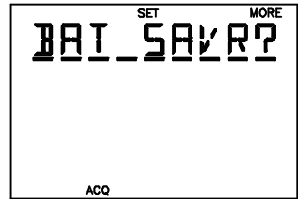

- Press MORE until "SIMULATR?" is displayed, then press the ENT key. You have just selected simulator mode.

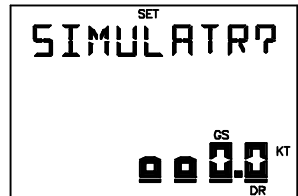

### Set the simulation speed...

- With the cursor under the ground speed field, press 0, 1, 5, followed by the ENT key, to indicate 15 knots (you may enter any speed you wish up to 90 knots). The simulation speed is now set.

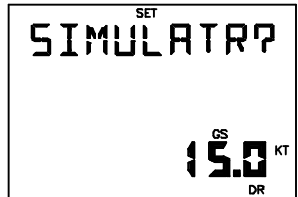

### GOTO GARMIN...

- Press GOTO. The Active Route Page will be displayed with the cursor under the GOTO waypoint name.

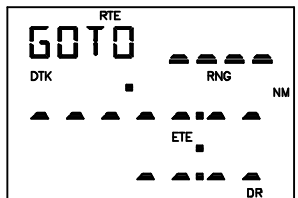

- With the cursor under the GOTO waypoint name, enter the waypoint name GRMN. Begin by pressing the 3 key (which also has a “G” printed on it). The letter “H” is displayed. Press the left or right arrow key until “G” is displayed. Press the 6 key followed by the left or right arrow key until “R” is displayed. Press the 5 key followed by the left or right arrow key until “M” is displayed. Press the 5 key. The letter “N” is displayed. When finished, press the ENT key. The CDI Page will be displayed which indicates your present speed (GS), track (TRK), range (RNG), and bearing (BRG) to the waypoint GRMN.

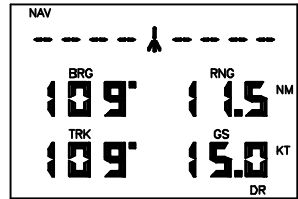
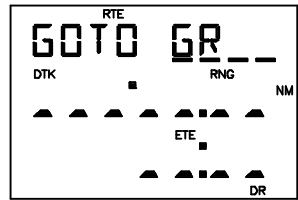

### Examine navigation information...

- Press an arrow key to place the cursor under line one. Press MORE to view the GOTO waypoint.
- Use the arrow keys to move the cursor under the fields on lines two and three. Press MORE to select a different display option.

### Experiment with your GPS 50!

- Now that you are on your way to GARMIN, why don't you take some time to experiment with the GPS 50? Press each page selection key to become familiar with available pages. Practice using the cyclic fields to display new information. If you want, change the simulation speed.
- Create a waypoint of your own and GOTO it.
- If you have not customized your unit, this may be a good time to review Chapter 4 for information concerning custom settings. Doing so will help you understand what each setting will do.
- If you wish to stop the simulation, simply turn the GPS 50 off.

# CHAPTER 4

## UNIT CUSTOMIZATION

The GPS 50 is designed for maximum flexibility. The unit features Setup Pages which allow you to customize your unit by setting a wide variety of parameters. You may cycle through the Satellite Status, Setup Menu, and Message Pages as illustrated below by pressing the SET key repeatedly until the desired page is displayed.

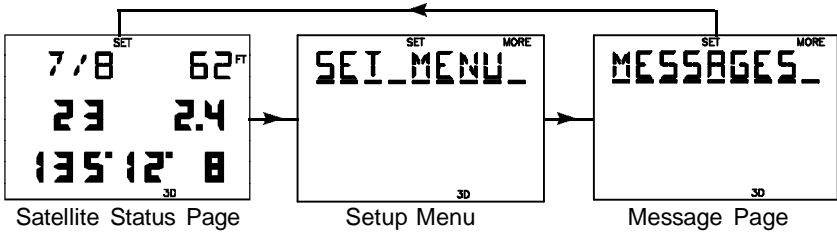

### 4.1 SETUP MENU

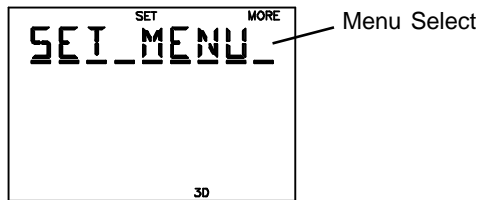

SETUP MENU

The Setup Menu displays the “SET MENU” title to let you access the underlying functions. To select a function from the menu, press the MORE key until the desired function is displayed, then press the ENT key. The available function selections are: “OP MODE?”, “ALARMS?”, “BACKLGT?”, “AUDIO?”, “UNITS?”, “CDI?”, “MAG VAR?”, “FILTERS?”, “OUTPUT?”, and “MAP DATM?”.

As you change setup parameters, keep in mind the changes you make become effective immediately if the option does not have a “?”. Otherwise, if the option has a “?”, you must press the ENT key to confirm it before the change becomes effective.

## 4.2 OPERATING MODE

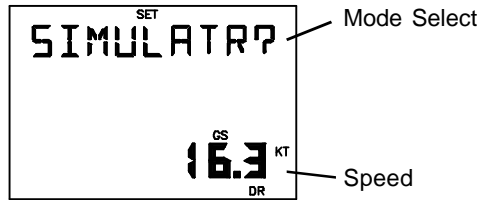

OPERATING MODE PAGE

The GPS 50 provides you with the capability to select from three modes which will allow you to operate your unit in the manner which best suits your needs.

### To select the operating mode...

- With the cursor under the mode select field, press MORE until the desired operating mode is displayed (Normal, Battery Saver, or Simulator mode as described in Section 2.7).
- Press ENT. The GPS 50 will now transition to the selected operating mode. (NOTE: Changing modes will cause a momentary interruption in navigation while the GPS 50 acquires satellites and recomputes navigation information.)

### To enter simulation speed...

- With the cursor under the ground speed field, enter your desired speed. The GPS 50 will now simulate a moving craft and compute navigation information using the speed.

## 4.3 USER SELECTABLE ALARMS

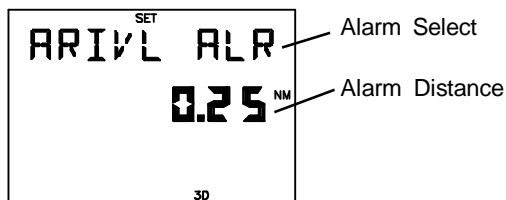

ALARM PAGE

The Alarm Page features three alarms: anchor drag, arrival, and CDI.

### To arm/disarm the anchor drag alarm...

- Press MORE until “ANCHR ALR” is displayed. Press the right arrow key to move the cursor to line two.
- To arm the anchor drag alarm, enter a non-zero distance. If your boat drifts away from the anchored position more than the specified distance, you will be informed with an alarm tone and the message “ANCHR ALR”.
- To disarm the alarm, enter zero for the distance.

### To arm/disarm the arrival alarm...

- Press MORE until “ARIVL ALR” is displayed. Press the right arrow key to move the cursor to line two.
- To arm the arrival alarm, enter a non-zero distance. The arrival alarm will inform you with an alarm tone and the message “ARIV \_\_\_\_” when you reach your destination. The alarm distance will also be used to inform you when you approach a route waypoint with the message “APCH\_\_”.
- To disarm the alarm, enter zero for the distance.

### To arm/disarm the CDI alarm...

- Press MORE until “CDI ALARM” is displayed. Press the right arrow key to move the cursor to line two.
- To arm the CDI alarm, enter a non-zero distance. The CDI alarm will notify you with an alarm tone and the message “CDI ALARM” if your craft has deviated from course beyond the limit you set. (This can be useful while navigating a narrow channel.)
- To disarm the alarm, enter zero for the distance.

## 4.4 BACKLIGHTING TIMEOUT

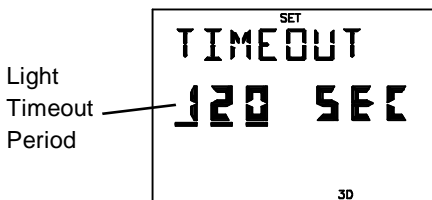

BACKLIGHTING PAGE

The GPS 50 will automatically turn the backlighting off after a specified number of seconds (backlighting is restored by pressing any key). If you are using battery power, this feature will help you extend battery life.

### To change the timeout period...

- With the cursor under the light timeout period, enter a non-zero value.
- To disable the backlighting timeout, simply enter zero (this means the backlighting will never turn off while the unit is operating).

## 4.5 AUDIO SETTINGS

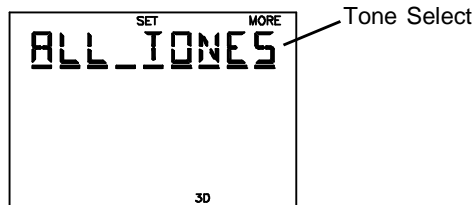

AUDIO SETUP PAGE

The Audio Setup Page allows you to select the characteristics of the audio tones.

### To select audio tones...

- With the cursor under the tone select field, press MORE until the desired tone setting is selected. Select “ALL TONES” to turn on both message and keypress feedback, “MSG TONE” to turn on message tone only, or “NO TONES” to turn off both.

## 4.6 NAVIGATION UNITS

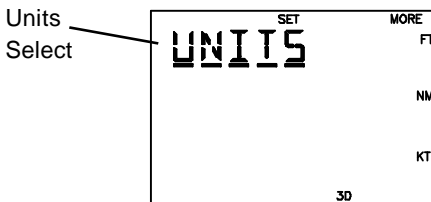

UNITS PAGE

The GPS 50 allows you to select the distance, speed, and altitude units that best suit your needs.

### To select navigation units...

- Press MORE to select the desired combination of distance, speed, and altitude units. You may select from Nautical units (nm, kt, ft), Statute units (mi, mh, ft), or Metric units (km, kh, mt).

## 4.7 CDI SCALE

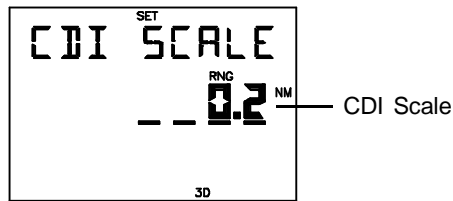

CDI SCALE PAGE

The GPS 50 allows you to set the scale for the CDI displayed on the CDI Page (see Section 3.5). The CDI scale refers to the distance that is represented by the CDI. For example, if your CDI scale is set to 1.0 nautical mile, the ends of the CDI represent left and right 1.0 nautical mile of cross track error.

### To set the CDI scale...

- With the cursor under the CDI scale field, enter the desired value.

## 4.8 MAGNETIC VARIATION

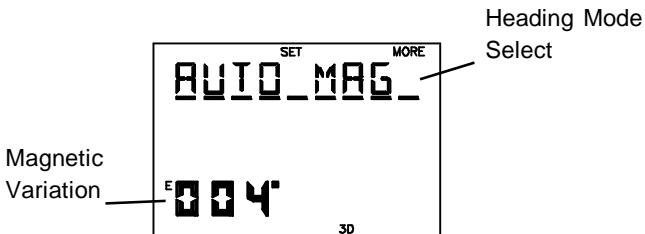

MAGNETIC VARIATION PAGE

The GPS 50 offers you three magnetic variation options. You may select true, automatic magnetic, or user magnetic heading correction for all track, course, and heading information. If you select true heading, all information displayed on other pages will be referenced to the true North pole. If you select automatic magnetic heading, all information will be corrected with the magnetic variation computed by the GPS 50. If you select user magnetic heading, all information will be corrected by the magnetic variation you enter.

### To select true heading...

- With the cursor under the heading mode select field, press MORE until “TRUE HDG” is displayed.

### To select automatic magnetic heading...

- With the cursor under the heading mode select field, press MORE until “AUTO MAG” is displayed. The computed magnetic variation at the present position will be displayed.

### To select user magnetic heading...

- With the cursor under the heading mode select field, press MORE until “USER MAG?” is displayed. Press ENT.
- With the cursor under the magnetic variation field, enter the desired value. (If the direction [E, W] is incorrect, press CLR until the correct direction is displayed, then enter the numeric value.)

## 4.9 FILTER SETTINGS

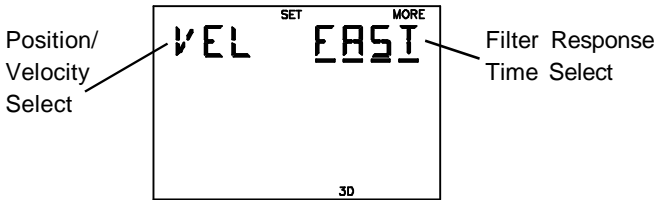

### FILTER SETTINGS PAGE

The GPS 50 allows you to choose the filter response time for position and velocity outputs. This may aid you in smoothing the data in rough seas or for sail boating.

### To select filter response time...

- With the cursor under the position/velocity select filter, press MORE to select “VEL” or “POSN”. Press ENT.
- Press MORE to select FAST (3 seconds), MED (20 seconds), SLOW (120 seconds), or AUTO.

Typical users will want to choose the “Auto” setting for optimal position and velocity filtering. This will allow the GPS 50 to respond quickly to changes in heading and speed while providing smooth data during cruise.



## 4.10 OUTPUTS

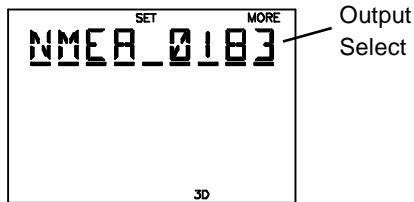

### OUTPUT PAGE

You may select the output data format for your interface requirements.

#### To select the GPS 50 output format...

- Press MORE until the desired output format is displayed. “NMEA 0180”, “NMEA 0182” (also known as NMEA 0180 Complex) and “NMEA 0183” are available for interfacing with other marine electronic devices (see Appendix C for more information on NMEA interfaces). Alternatively, you may select “NO OUTPUT” if you do not use the interface (this will help extend battery life).

## 4.11 MAP DATUM

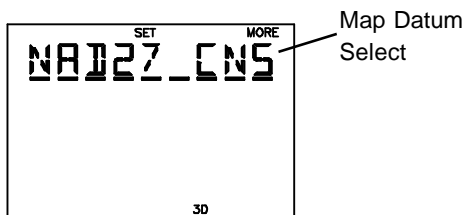

### MAP DATUM PAGE

The GPS 50 calculates your position based on the WGS-84 map datum. If your charts (or other electronic devices) are created using a different datum, you must set the GPS 50 map datum for consistency (a position in the WGS-84 datum could differ by 1000 feet or more from one calculated using another datum). The GPS 50 provides 101 standard map datums and allows you to enter your own, if necessary. Check the datum in the legend of your chart and the manuals of your other navigation equipment interfaced to the GPS 50 and set the map datum accordingly.

### To select a standard map datum...

- With the cursor under the map datum select field, press MORE or the arrow keys until the desired map datum is displayed. Refer to Appendix C for a list of the standard map datums.

### To select a user map datum...

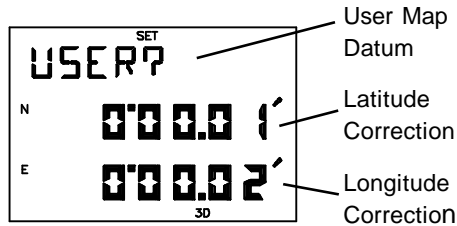

- With the cursor under the map datum select field, press MORE until "USER?" is displayed. Press ENT.
- Enter the latitude and longitude corrections in the appropriate fields. (Remember, if the direction [E, W, N, S] is incorrect, press CLR until the correct direction is displayed, then enter the numeric value.)

# CHAPTER 5

## NAVIGATION PLANNING

The GPS 50 provides a menu page under the NAV key which allows you to select from a menu of time and planning functions. You may cycle through the Navigation Pages by pressing the NAV key repeatedly until the desired page is displayed.

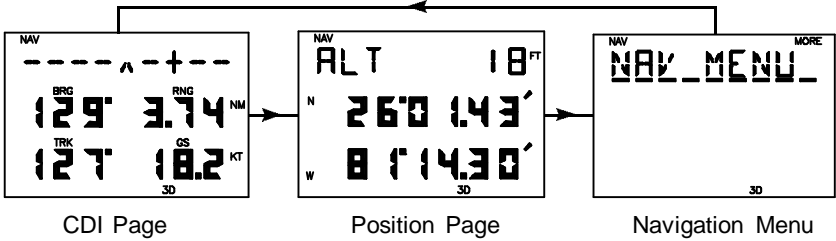

### 5.1 NAVIGATION MENU

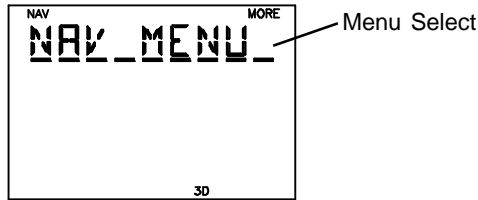

NAVIGATION MENU

The Navigation Menu displays the “NAV MENU” title to let you access the underlying functions. To select a function from the menu, press the MORE key until the desired function is displayed, then press the ENT key. The available function selections are: “DATE TIME?” (current date/time), “TIMER?” (count down/elapsed timer), “TRIP PLN?” (trip planning), “SUN CALC?” (sunrise/sunset time calculation), and “ALRM CLK?” (alarm clock).

### 5.2 DATE AND TIME

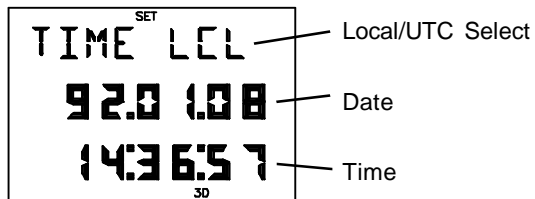

DATE/TIME PAGE

The Date/Time Page displays the date and time in either UTC or local format. In addition, the format you select on this page is used for time displays on other pages.

### To change the time display...

- Press MORE to select either “LCL” (local) or “UTC”.

The GPS 50 will keep track of local as well as UTC time. UTC, which is essentially the same as Greenwich Mean Time (GMT), does not change with local time zones. It is the time at 0 degrees longitude which passes through the city of Greenwich, England. The GPS 50 automatically corrects the UTC date and time with information received from the satellites.

Due to the irregular nature of time zones, the GPS 50 does not attempt to correct your local time when you pass from one time zone to another.

### To update your local date and time...

- Press MORE until “LCL” is displayed in the time selection field.
- With the cursor under the date field, enter your local date in year, month, day format.
- With the cursor under the time field, enter your local time in 24-hour format.

## 5.3 EVENT TIMER

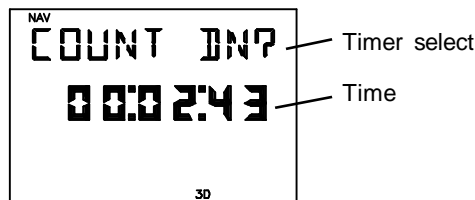

EVENT TIMER PAGE

The GPS 50 features a timer which can be used as either an elapsed timer or count down timer.

### To set the count down timer...

- With the cursor under the time field, enter the count down time in hours, minutes, and seconds.
- With the cursor under the selection field, press MORE until “COUNT DN?” is displayed.

- Press ENT. The timer will start counting down. When the timer reaches zero, you will be informed with the message “TIMER EXP” and the timer will begin to count up showing you the elapsed time since the timer has expired.

### **To stop the count down timer...**

- With the cursor under the selection field, press MORE until “STOP?” is displayed.
- Press ENT. The count down timer will freeze at its last value.

The elapsed timer counts up instead of counting down. It does not generate a message, but simply measures time from the point at which it was started.



### **To start the elapsed timer...**

- With the cursor under the time field, enter the start time in hours, minutes, and seconds (you may start or restart the elapsed timer from a non-zero time).
- With the cursor under the selection field, press MORE until “COUNT UP?” is displayed.
- Press ENT. The timer will start counting up.

### **To stop the elapsed timer...**

- With the cursor under the selection field, press MORE until “STOP?” is displayed.
- Press ENT. The elapsed timer will freeze at its last value.

## 5.4 TRIP PLANNING

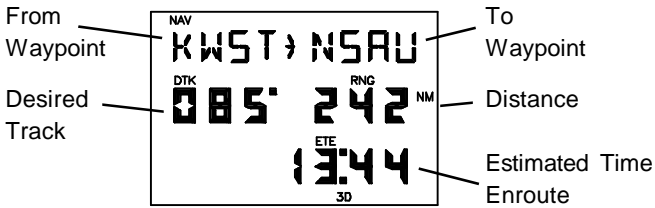

TRIP PLANNING PAGE

The Trip Planning Page allows you to calculate the distance, desired track, and time requirement between any two waypoints.

### To perform trip planning...

- Enter the from waypoint. If you wish to use your present position, leave it blank.
- Enter the to waypoint. If you wish to use your present position, leave it blank.

The GPS 50 will display the great circle distance and bearing between the two geographical points. In addition, the time requirement will be displayed based on your present speed.

## 5.5 SUNRISE/SUNSET

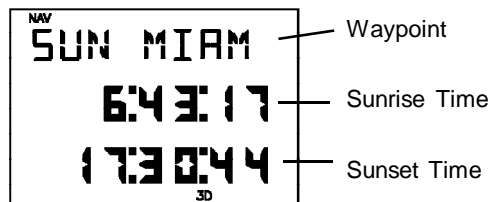

SUNRISE/SUNSET PAGE

The Sunrise/Sunset Page will display sunrise and sunset times for any waypoint. This can be helpful if you wish to be at your favorite fishing spot at the crack of dawn, or if you wish to return home before dark.

### To calculate sunrise and sunset times...

- Enter the desired waypoint name. If you wish to use your present position, leave it blank. The GPS 50 will display the sunrise and sunset

times for the current date at the waypoint. The sunrise and sunset times will be displayed in local or UTC time based on your selection on the Date/Time Page (see Section 5.2).

## 5.6 ALARM CLOCK

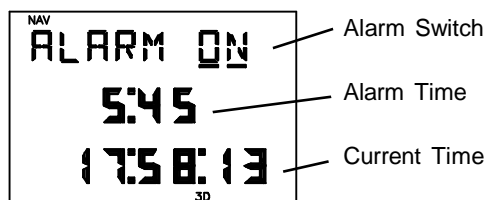

ALARM CLOCK PAGE

The Alarm Clock Page on the GPS 50 allows you to concentrate on other important tasks while the GPS 50 watches the clock for you!

### To set the alarm clock...

- Press MORE to select "ON" for the alarm clock.
- Enter the desired alarm time in 24-hour format (line three displays the current time). Enter local or UTC time based on your selection on the Date/Time Page (see Section 5.2). When the alarm time has been reached, the GPS 50 will inform you with the message "ALARM CLK".

### To cancel the alarm clock...

- Press MORE to select "OFF" for the alarm clock.

# CHAPTER 6

## ROUTES

### 6.1 NAVIGATING USING ROUTES

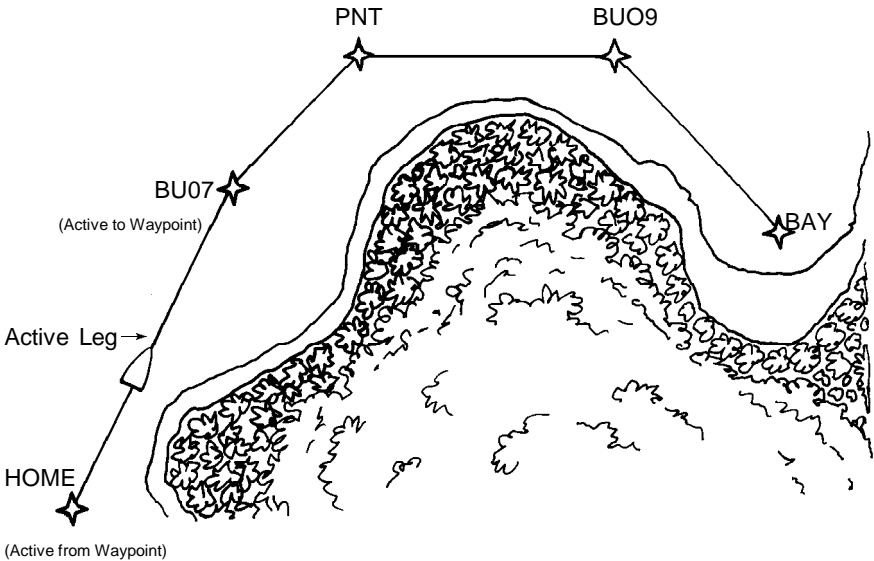

The GPS 50 offers a route navigation feature for you to navigate along a predefined sequence of waypoints.

The GPS 50 route capability allows you to create and store ten routes, each containing up to nine waypoints. Routes 1 to 9, the storage routes, can be activated to travel either in the order you defined the waypoints or in reverse order. Route A, the active route, is the route you are navigating. The waypoint toward which you are navigating is called the “active to” waypoint. The waypoint immediately behind you is called the “active from” waypoint. The line that connects the “active from” and “active to” waypoints is called the “active leg”.

The GPS 50 features automatic leg selection which will select the route segment closest to your position as the active leg. The GPS 50 also features automatic leg sequencing. As you pass a waypoint in the route, the unit will automatically select the next waypoint as the “active to” waypoint.



You may alternate between the two route pages as illustrated below by pressing the RTE key.

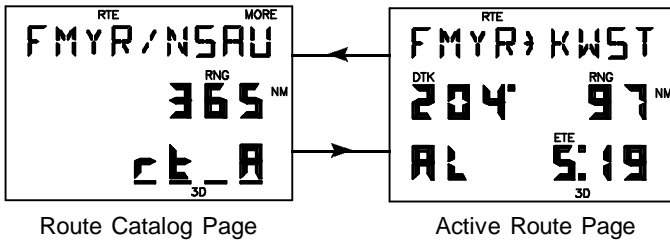

## 6.2 ROUTE CATALOG

First and Last Route Waypoints

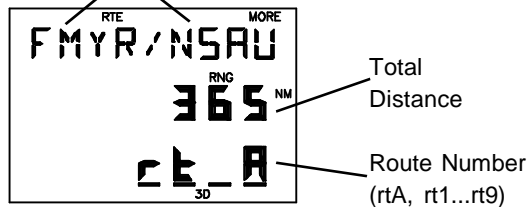

### ROUTE CATALOG PAGE

The Route Catalog Page provides a list of the routes stored in the GPS 50. This page shows the route number, first/last waypoints in the route, and the total distance traversed by the route. For example, in the illustration above, route A begins at FMYR (Fort Myers, Florida), ends at NSAU (Nassau in the Bahamas), and is 365 nautical miles long.

The Route Catalog Page displays one route at a time. Additional routes may be displayed by pressing the MORE key while the cursor is under the route number. Alternatively, you may press number key 1 through 9 (or 0 for active route) to select your desired route.

The Route Catalog Page allows you to initiate various operations on the route you have selected. By pressing ENT, the Route Catalog Page will change as illustrated below.

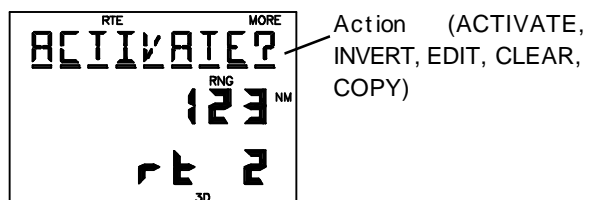

You may press the MORE key to select route editing, activation, copy and deletion functions.

### 6.3 EDITING ROUTES

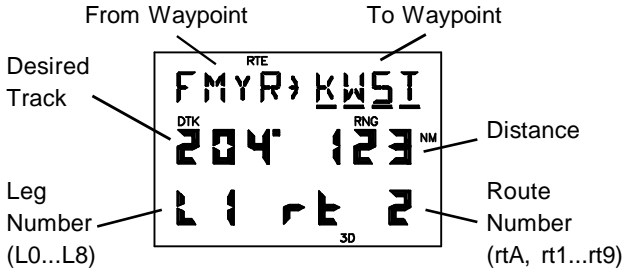

ROUTE REVIEW PAGE

The Route Review Page displays the waypoints of a route and allows you to create, change, and review routes. It shows the route and leg numbers, the two waypoints composing the leg, and the distance and desired track between the two waypoints. This page shows one leg at a time. You may press the arrow keys to review additional legs. (As you scroll past the first or last waypoint, it will return to the Route Catalog Page.)

#### To create a route...

- Select an empty route on the Route Catalog Page and press ENT. The Route Review Page will be displayed as illustrated below.

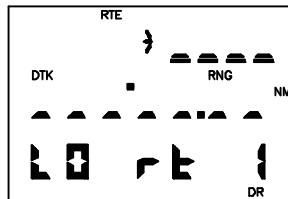

- With the cursor under the "to waypoint", enter up to nine waypoints to create the route.
- Press RTE to return to the Route Catalog Page when editing is completed.

#### To display the Route Review Page...

- Select the desired route on the Route Catalog Page and press ENT.

- Press MORE until “EDIT?” is displayed. Press the ENT key. The Route Review Page will be displayed showing the waypoints of the first leg. You may view additional legs by pressing the left or right arrow key while the cursor is under the “to waypoint.”
- Press RTE to return to the Route Catalog Page. To insert a waypoint into a route...

### **To insert a waypoint into a route...**

- Select the desired route on the Route Catalog Page and press ENT.
- Press MORE until “EDIT?” is displayed. Press ENT. The Route Review Page will be displayed.
- With the cursor under the “to waypoint”, press the arrow keys to scroll through the waypoints until the waypoint where you wish to insert appears.
- Enter the new waypoint. The existing waypoints will shift to the right to make room for the new waypoint. (If you attempt to add a waypoint in a route that already contains nine waypoints, you will be informed with the message “RTE FULL”. )
- Press RTE to return to the Route Catalog Page when editing is completed.

### **To delete a waypoint from a route...**

- Select the desired route on the Route Catalog Page and press ENT.
- Press MORE until “EDIT?” is displayed. Press ENT. The Route Review Page will be displayed.
- With the cursor under the “to waypoint”, press the arrow keys to scroll through the waypoints until the waypoint you wish to delete appears.
- Press CLR followed by ENT to delete the waypoint.
- Press RTE to return to the Catalog Page when editing is completed.

### **To clear a route...**

- Select the desired route on the Route Catalog Page and press ENT.
- Press MORE until “CLEAR?” is displayed. Press ENT. All waypoints are cleared from the route.

The waypoints of an existing route may be copied to an empty route using the Route Catalog Page. This is useful if you wish to store the contents of

the active route (route A) before activating another route. Also, you may copy a route and then make changes to form a new route.

### To copy a route...

- Select the desired route on the Route Catalog Page and press ENT.
- Press MORE until “COPY?” is displayed. Press ENT. The Route Catalog Page will appear as illustrated below.

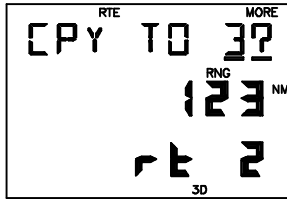

- Press MORE until the route number of the empty route to which you wish to copy is displayed, then press ENT. (If no empty routes are available, you will be informed with the message “NO EMP RT”.)

## 6.4 ACTIVATING ROUTES

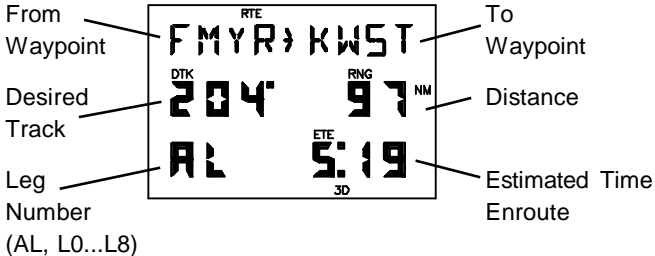

ACTIVE ROUTE PAGE

Routes are activated using the Route Catalog Page. You may activate any route in the displayed order or in reverse order. (NOTE: When a new route is activated, the previous contents of route A will be overwritten. If you wish to save route A, be sure to copy it to an empty route first.)

### To activate a route...

- Select the desired route on the Route Catalog Page and press ENT.
- If you wish to activate the route in the displayed order, press MORE until “ACTIVATE?” is displayed, then press ENT.
- If you wish to activate the route in reverse order, press MORE until “INVERT?” is displayed, then press ENT.

Immediately after activating a route, the Active Route Page will be displayed. This page displays the leg number (L1 to L8, meaning legs 1 through 8 of the selected route, or AL meaning the active leg), the two waypoints composing the leg, the desired track between the two waypoints, and the enroute distance and time from your present position to the “to waypoint”.

Notice the “AL” in the above illustration. This indicates the displayed leg is the “active leg”, where FMYR is the “active from” waypoint and KWST is the “active to” waypoint. (NOTE: When activating a route, check the active leg to be sure you agree with the selection. If not, use the GOTO function to select the “active to” waypoint you desire.) You may view additional route legs by pressing the left or right arrow key while the cursor is under the “to waypoint”.

### **To add a waypoint to the active route...**

- Use the cursor under the “to waypoint”, press the arrow keys to scroll through the waypoints until the waypoint where you wish to insert the new waypoint appears.
- Enter the waypoint name. The existing waypoints will shift to the right to make room for the new waypoint.

### **To delete a waypoint from the active route...**

- With the cursor under the “to waypoint”, press the arrow keys to scroll through the waypoints until the waypoint you wish to delete appears.
- Press CLR followed by ENT to delete the waypoint.

## 6.5 BUILDING ROUTES USING AutoStore™

GARMIN's AutoStore™ feature, introduced in Section 3.4, allows you to capture your position and store it in the route of your choice at the touch of a button. By doing so, you are building a route consisting of waypoints stored along the path you travel.

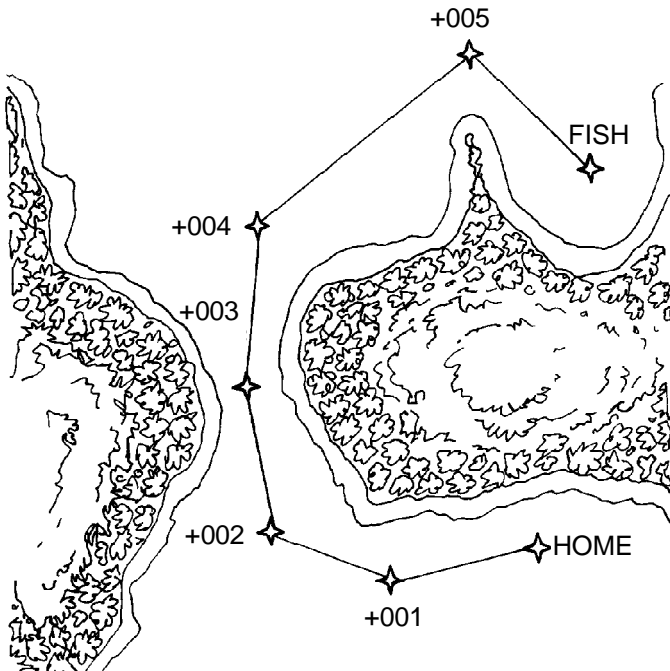

Suppose you are heading out for a long day of fishing and want to record your path as you proceed to your destination so that you can safely return from the opposite direction. Simply use the AutoStore™ function to record strategic waypoints as you travel and insert these waypoints in an empty route from the AutoStore™ Page.

### To record your route...

- Press NAV until the Position Page is displayed.
- Press ENT. The AutoStore™ Page will be displayed with the default waypoint name.
- If you wish to give the waypoint a name of your own, move the cursor under the waypoint name and enter the name of your choice.

- With the cursor under the storage select field, press MORE until the desired route is displayed (e.g., Route 5 as illustrated below).

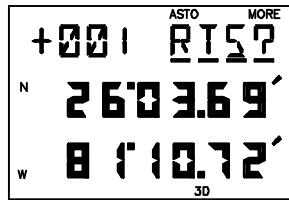

This route will be the default storage selection for subsequent AutoStore™ operations until it is changed or the route becomes full.

- With the desired route selected, press ENT. The AutoStore™ waypoint will be stored in the waypoint memory and appended to the selected route.

When you are ready to return, use the Route Catalog Page to activate the route you created in reverse order. The GPS 50 will automatically guide you back to your destination by passing over the waypoints you created! As an added benefit, you now have a route that will take you back to your fishing spot at any time.

# CHAPTER 7

## SAMPLE SIMULATED TRIP

Now that you have gained a good understanding of the GPS 50 advanced features, you are ready to embark on a sample route navigation trip! (The sample illustrations in this chapter assume that the factory default settings have not been changed. If you have changed these parameters, the unit may display slightly different data than presented here.)

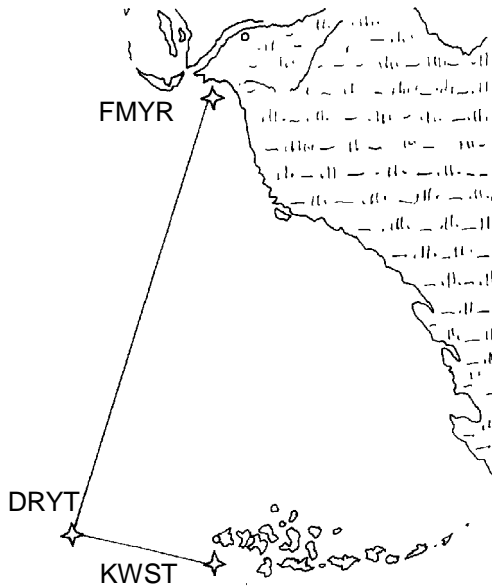

You are planning a trip from Ft. Myers, Florida to the Dry Tortugas and then on to Key West, Florida. Turn on your GPS 50. The power on notices will be displayed followed by the Satellite Status Page as illustrated below.

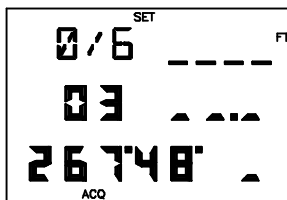

The GPS 50 is ready to accept your commands!



## Select the simulator mode...

- Press SET until the Set Menu is displayed.

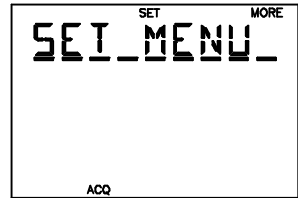

- Press MORE until "OP MODE?" is displayed.

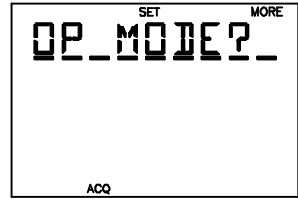

- Press ENT to display the Operating Mode Page.



- Press MORE until "SIMULATR?" is displayed, then press ENT. You have just selected the simulator mode.

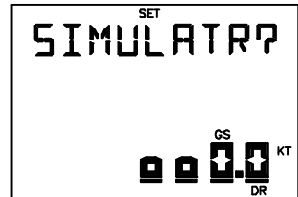

## Set the simulation speed...

- With the cursor under the speed field, press 0, 1, 5, followed by the ENT key, to indicate 15 knots (you may enter any speed you wish up to 90 knots). The speed is now set.

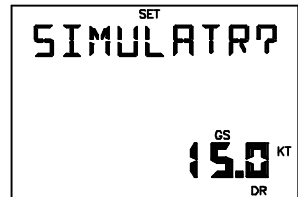

Since your trip starts at Ft. Myers, you need to set your GPS 50 position to that location.

### Set your GPS 50 position...

- Press NAV until the Position Page is displayed. NOTE: The position will be changing by your entered speed.

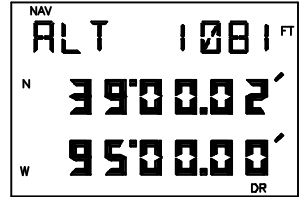

- Press an arrow key to move the cursor under the latitude.

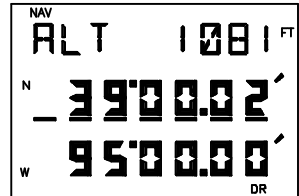

- Press CLR until the “N” hemispheric designation is displayed, then press the 2, 6, 3, 5, 1, 7 keys to enter N26°35.17'. Press ENT to complete the latitude. The cursor will move to the longitude.

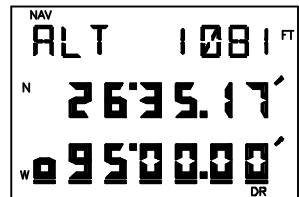

- Press CLR until the “W” hemispheric designation is displayed, then press the 0, 8, 1, 5, 1, 8, 1 keys to enter W081°51.81'. Press ENT to complete the longitude. Your position is now initialized to Fort Myers, Florida.

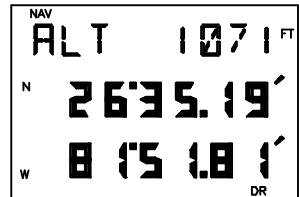

Now you need to create the waypoints used in the sample trip.

### Create waypoints...

- Press WPT to display the Waypoint Definition Page.

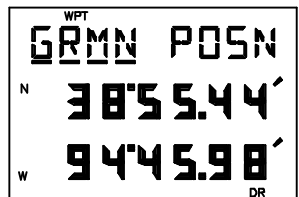

Create a waypoint named KWST, the Key West area of South Florida.

- With the cursor under the waypoint name, enter KWST. Begin by pressing the 4 key (which also has a “K” printed on it). The letter “K” is displayed. Press the 8 key (which also has a “W” printed on it). The letter “W” is displayed. Press the 7 key (which also has an “S” printed on it) followed by the left or right arrow key until “S” is displayed. Press the 7 key (which also has a “T” printed on it). The letter “T” is displayed. When finished, press the ENT key. The cursor will move under the view select field.

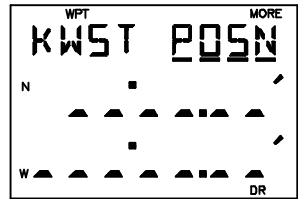
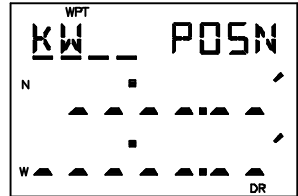

- Press ENT. The cursor will move under the latitude field.

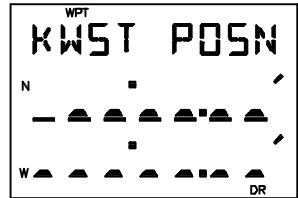

- Enter the latitude of Key West, Florida (N24°33.34') by pressing 2, 4, 3, 3, 3, 4. Press ENT when you are finished. The cursor will automatically move under longitude.

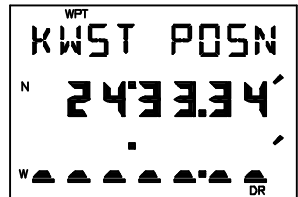

- Enter the longitude of Key West, Florida (W081°45.58') by pressing 0, 8, 1, 4, 5, 5, 8. Press ENT when you are finished. You have just created the waypoint KWST.

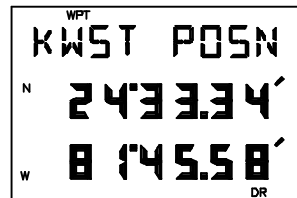

Create a waypoint named DRYT which will be located in the Dry Tortugas area of the Gulf of Mexico.

- Move the cursor back under the waypoint name field.

- Enter the waypoint name DRYT, latitude (N24°38.00') and longitude (W082°55.07').

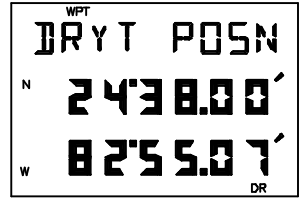

Create a waypoint named FMYR which is the name for Fort Myers, Florida.

- Move the cursor back under the waypoint name field.
- Enter the waypoint name FMYR, latitude (N26°35.17'), and longitude (W081°51.81').

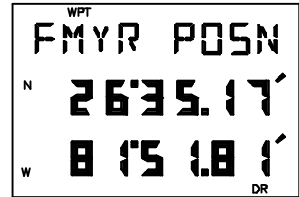

Now that the sample waypoints are in memory, create the sample route using these waypoints.

### Create the sample route...

- Press RTE until the Route Catalog Page is displayed.

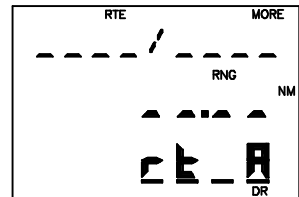

- Press MORE until the route 1 is displayed. (NOTE: This example assumes route 1 is empty.)

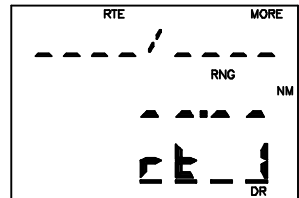

- Press ENT. You have just selected the Route Review Page for route 1. Notice that the route does not contain any waypoints ("L0" indicates leg 0 is displayed).

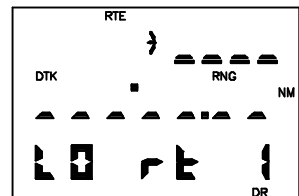

- Enter the waypoint name FMYR followed by the ENT key. You have just entered Ft. Myers as the waypoint from which your voyage will start.

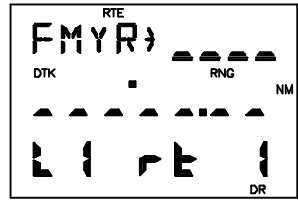

- Enter DRYT as the second waypoint of the route.

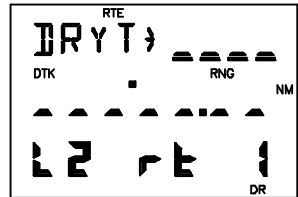

- Enter KWST as the third waypoint of the route. This is the waypoint where your voyage will end.

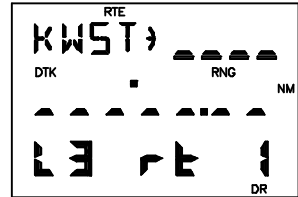

If you haven't already guessed, you have just created a route that will take you from Fort Myers to the Dry Tortugas and on to Key West. You may review the route leg information (including desired track and range) by pressing the left arrow key to scroll through the route waypoints.

### Activate the sample route...

- Press RTE to display the Route Catalog Page again.

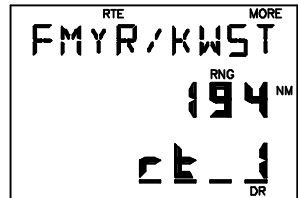

- Press ENT.

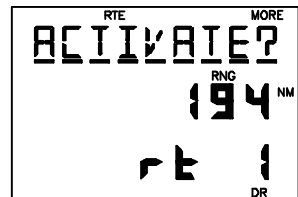

- With the cursor under “ACTIVATE?”, press ENT to activate the sample route. The Active Route Page will be displayed.

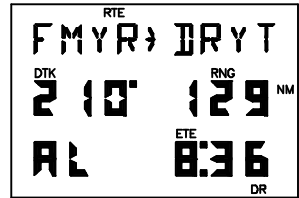

The sample route is now active. This page displays the waypoint you are going from (FMYR) and the waypoint you are going to (DRYT) on line one as well as desired track, distance and time information on lines two and three.

**Examine navigation information...**

- Press NAV to display the CDI Page. The page will indicate CDI, bearing, range, track and speed information.

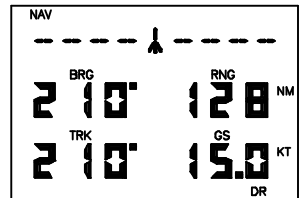

- Press an arrow key to place the cursor under line one. Press MORE to view the active leg. Press the MORE key again to view the CDI.
- Use the arrow keys to move the cursor under the fields on lines two and three. Press MORE to select a different display option.

**Experiment with your GPS 50!**

- Now that you have started on your fantasy trip to the Dry Tortugas, why don't you take some time to experiment with the GPS 50? Press each page selection key to become familiar with available pages. Practice using the cyclic fields to display new information. Examine the Active Route Page as the simulation progresses. If you want, change the simulation speed.
- As you progress through the simulation, the GPS 50 will alert you with a message when you are within one minute of reaching the waypoint DRYT. When passing DRYT, the GPS 50 will automatically sequence to the next waypoint which is KWST.

- At some point during the simulation, you may wish to try the GOTO function. Suppose severe weather in the Dry Tortugas area was reported over your VHF com. You may wish to shorten your trip by heading directly to Key West, Florida. Simply press GOTO. The Active Route Page will be displayed.

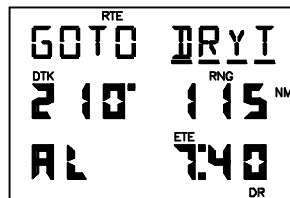

- Enter KWST. The GPS 50 will set an instantaneous course and you are on your way to Key West!

# APPENDIX A

## MESSAGES

The GPS 50 uses the Message Page to communicate important information to you. Some messages are advisory in nature, others are warnings that may require your intervention. This appendix provides a complete list of GPS 50 messages and their meanings. Please pay careful attention to all messages.

**ACTV WPT** - An attempt has been made to modify the position of the “active to” or “active from” waypoint. The GPS 50 will not allow the modifications.

**ADJST OSC** - The GPS 50 has detected excessive drift in its internal crystal oscillator which may result in longer acquisition time. The unit should be taken to an authorized GARMIN service center as soon as possible.

**ALARM CLK** - The alarm clock time has been reached.

**ANCHR ALR** - Your craft has drifted outside the anchor drag alarm radius set on the Alarm Page.

**APCH \_\_\_\_** - You are less than one minute from reaching the indicated waypoint or your craft has entered the arrival alarm circle for the indicated waypoint.

**ARIV \_\_\_\_** - Your craft has entered the arrival alarm circle for the indicated waypoint.

**BATT LOW** - The battery pack is low on power. AA batteries should be replaced or the rechargeable battery pack should be recharged for continued operation.

**CDI ALARM** - Your course deviation has exceeded the limit you specified on the Alarm Page.

**DATA LOST** - Stored user data, including waypoints, routes, and satellite orbital data has been lost due to a low memory battery.

**EXST \_\_\_\_** - You have renamed the waypoint on the AutoStore™ Page or Waypoint Definition Page with a name that already exists in memory. Enter a waypoint name that does not exist.

**HIGH EPE** - The accuracy of the GPS 50 position is degraded beyond 500 meters due to satellite geometry or data quality. Additional cross checking should be performed by the user to verify the integrity of the GPS 50 position.



**MEM BATT** - The battery that sustains user memory is low and should be replaced by an authorized GARMIN service center as soon as possible. Failure to do so may result in loss of stored data, including all waypoints and routes.

**MEM FULL** - The waypoint memory is full. You should delete unused waypoints to make room for new waypoints.

**NO EMP RT** - There are no empty routes available into which another route may be copied. The GPS 50 will not allow you to copy a route to a non-empty route.

**POOR CVRG** - The GPS 50 cannot acquire sufficient satellites necessary to provide navigation.

**RCVR FAIL** - The GPS 50 has detected a failure in the receiver hardware. If the message persists, the GPS 50 is unusable and should be taken to an authorized GARMIN service center.

**RE-INIT** - The GPS 50 is unable to compute a position. Initialize the position on the Position Page to within 1000 nautical miles of your actual position.

**ROM FAILD** - The GPS 50 has detected a failure in its permanent memory. If this message occurs, the unit is unusable and should be taken to an authorized GARMIN service center.

**ROUTE WPT** - An attempt has been made to delete a waypoint which is a member of one or more routes. You must remove the waypoint from all routes before the waypoint can be deleted.

**RTE FULL** - An attempt has been made to add more than nine waypoints to a route. The GPS 50 will not allow more than nine waypoints per route.

**SRCH SKY** - The GPS 50 is in search-the-sky mode. Allow the unit to complete its data collection before turning it off.

**TIMER EXP** - The count down timer has expired.

# APPENDIX B

## NAVIGATION TERMS

### B.1 DEFINITIONS

This section provides an illustration of and definitions for the navigation terms used in this manual.

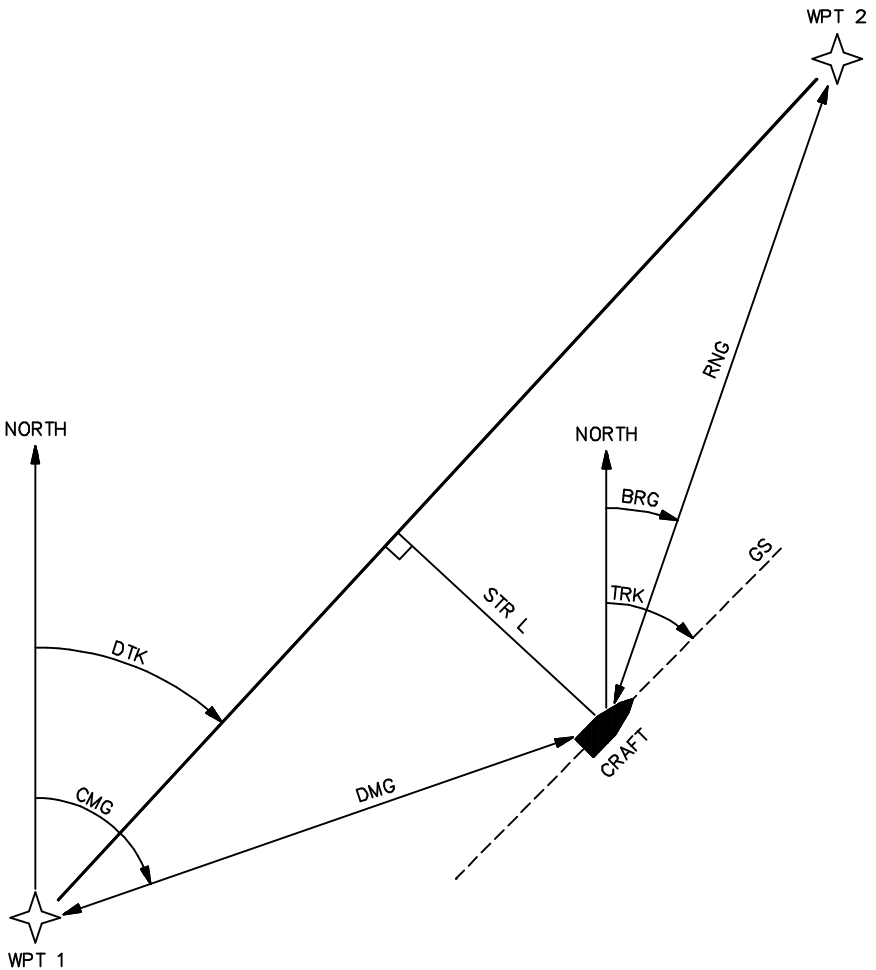

Velocity/time terms:

- GS** Ground speed. GS is the speed measured relative to the ground; also known as velocity over ground (VOG).
- VMG** Velocity made good. VMG is velocity in the direction of the desired course. It is the speed at which you are closing on the “active to” waypoint.
- ETE** Estimated time enroute. ETE is the time it will take to reach the “active to” waypoint based on VMG.

Direction terms:

- DTK** Desired track. DTK is the course between the “from” and “to” waypoints.
- BRG** Bearing. BRG is the direction from your position to the “active to” waypoint.
- CTS** Course to steer. CTS is the recommended direction to steer in order to reduce cross track error and stay on course (see Section B.2 for an example using CTS).
- CMG** Course made good. CMG is the bearing from the “active from” waypoint to your position.
- TRK** Track. TRK is the direction of movement relative to the ground.
- TRN** Turn instruction. TRN is the difference between BRG or CTS (whichever you have displayed) and TRK. “L” indicates you should turn to the left, “R” indicate you should turn to the right. The degrees indicate the angle you are off course.

Distance terms:

- RNG** Range. RNG is the great circle distance from your position to the “to” waypoint.
- DMG** Distance made good. DMG is the distance from the “active from” waypoint to your position.
- STR** Steer direction and distance. “L” indicates you should steer to the left, “R” indicates you should steer to the right. The distance indicates how far you are off course.

## B.2 COURSE TO STEER (CTS)

Course To Steer is a GARMIN exclusive that recommends an optimal direction to steer that will guide you to the course and proceed efficiently along your route.

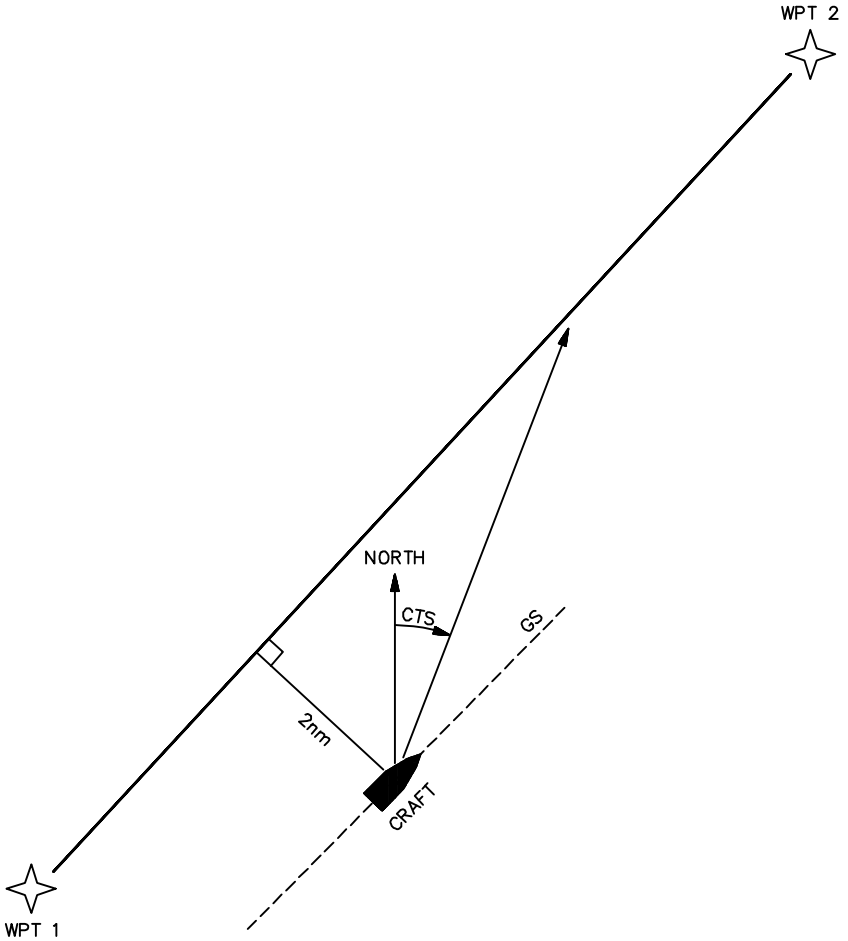

As an example, suppose you activate the route illustrated above. The GPS 50 chooses the closest leg with a desired track of 45 degrees but your position happens to be two nautical miles off course. The unit will automatically compute the optimal course to steer (which is 15° in this example). Press the NAV key until the CDI Page is displayed, then select “CTS” on line two and “TRN” on line three. Turn your craft according to the TRN direction until the TRN angle reaches zero. Continue to follow the TRN guidance, thus matching your track (TRK) with the recommended course to steer.

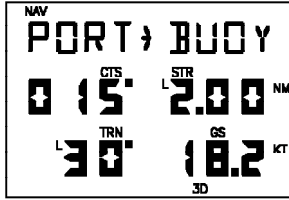

As you approach the course, CTS will slowly change and, once on course, will be identical to the desired track.

# APPENDIX C

## INSTALLATION AND MAINTENANCE

### C.1 SPECIFICATIONS

#### GPS 50 SPECIFICATIONS\*

---

##### PHYSICAL

Case:	Waterproof
Size:	Portable: 3.23"w x 6.26"h x 1.46"d (82mm x 159mm x 37mm) Fixed: 3.23"w x 4.87"h x 1.46"d (82mm x 124mm x 37mm)
Weight:	14 ounces (0.4 kg) without battery pack 19.5 ounces (0.55) with battery pack

##### POWER

Input	Alkaline battery pack (4 AA size) Rechargeable battery pack 12- or 24-volt DC with power cable (5-40 VDC) 115- or 230-volt AC with battery charger
Consumption	1.1 watts in Normal mode (without backlighting)

##### ENVIRONMENTAL

Temperature:	-15°C to +70°C (+5°F to +158°F ) operating -40°C to +70°C (-40°F to +158°F) storage
Humidity:	95% non-condensing

##### PERFORMANCE

Receiver:	MultiTrac™, tracking up to 8 satellites
Acquisition Time: (typical)	2 minutes 2D 2.5 minutes 3D 15 seconds Warm Start (with ephemeris)
Update Rate:	Once per second, continuously

Accuracy: Position: 15 meters (49 ft) RMS\*\*  
Velocity: 0.1 knots RMS steady state

Dynamics: 90 knots velocity, 3g dynamics

## INTERFACES

NMEA 0180

NMEA 0182

NMEA 0183 (Version 1.5; December 1987)

Approved sentences:

GPBWC, GPGLL, GPRMB, GPRMC, GPR00, GPWPL, GPXTE

Proprietary sentences:

PGRMA

Transmission rate:

GPBWC, GPGLL, GPRMB, GPRMC, GPXTE, and PGRMA transmitted once every two seconds.

GPR00 transmitted once every (# of route waypoints + 1) \* 2 seconds. e.g., if there are two route waypoints, this sentence will be transmitted once every six seconds.

GPWPL transmitted # of route waypoints times in (# of route waypoints + 1) \* 2 seconds. e.g., if there are two route waypoints, this sentence will be transmitted twice every six seconds.

---

## NOTES:

- \* All specifications are subject to change without notice.
- \*\* Subject to accuracy degradation to 100m 2DRMS under the United States Department of Defense imposed Selective Availability program.

## C.2 ELECTRICAL WIRING

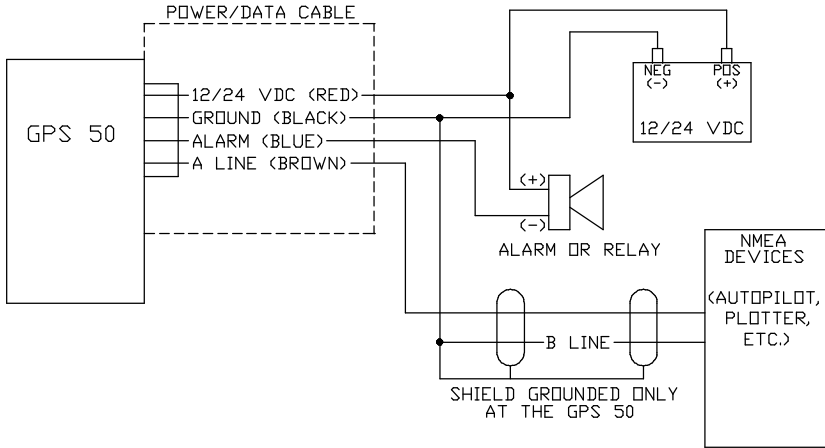

The GPS 50 power/data cable allows you to connect the unit to vehicle power systems, other marine electronics, and a remote alarm/beeper. The harness will plug into the connector located on the rear panel of the GPS 50.

### To connect to vehicle power systems...

- Connect the RED harness lead (with fuse) to the positive (+) side of a 5-40 volt DC power source.
- Connect the BLACK harness lead to the negative (-) side of the 5-40 volt DC power source.

The GPS 50 will drive a remote alarm or relay that requires no more than 100 milliamps of current. (**WARNING:** Devices which draw current in excess of 100 milliamperes may damage your unit and will void your warranty. Consult the instructions included with the remote alarm or relay for current drain information.)

### To connect to a remote alarm system...

- Connect the BLUE harness lead to the negative side of a transistor alarm or relay switch.
- Connect the positive side of the alarm or relay to the positive side of the 5-40 volt DC power source.

The GPS 50 may be connected to other marine electronics such as an autopilot or plotter which use an NMEA 0180, NMEA 0182 or NMEA 0183



data interface. The unit can provide data for up to three NMEA “listeners” simultaneously. Refer to installation instructions of these devices for further information.

### To connect the GPS 50 to an NMEA electronic device...

- Connect the BROWN harness lead to the NMEA “A” line of a two-wire, shielded cable.
- Connect the BLACK harness lead to the NMEA “B” line of the shielded cable.
- Connect the BLACK harness lead to the shield of the shielded cable. (The opposite end of the shield should not be grounded.)

### C.3 UNIVERSAL MOUNT INSTALLATION

The GPS 50 is equipped with a universal mount for fixed installations. The universal mount may be installed above the dash or attached to a surface as shown below.

Although your GPS 50 is designed to withstand the marine environment, it is recommended that it be mounted in a location which provides protection from sun and spray. Before permanent mounting, you may wish to apply power to the unit and look at the display in the desired mounting location to ensure you have the desired viewing angle.

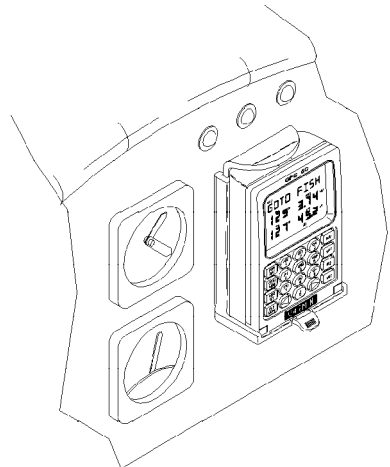
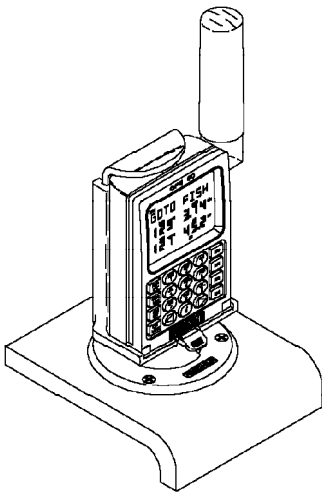

## To install universal mount above dash...

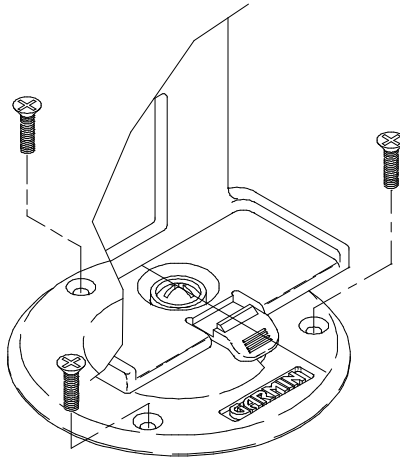

- The universal mount is completely assembled and ready for fixed installation above dash. Mount the base to the boat dash using appropriate screws (#8 flat head screws are recommended).

## To install universal mount on a surface...

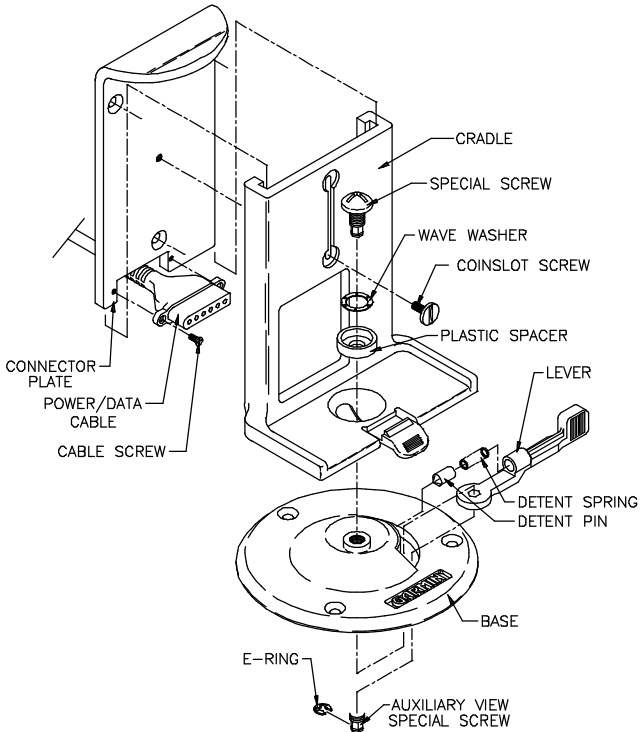

- Remove the E-ring from the special screw under the base using a pair of pliers.
- Remove the lever.
- Unscrew the special screw and remove it from the base.
- The base, lever, detent pin, detent spring, plastic spacer, and wave washer may be set aside (these parts are not used for surface installation).
- Remove the screws which mount the power/data cable and remove the cable.
- Unscrew and remove the coin slot screw and remove the cradle.
- Drill an oblong hole in the mounting surface to allow clearance for the power/data cable connector.
- Mount the connector plate to the dash using appropriate screws (#8 flat head screws are recommended).
- Slide the cradle onto the connector plate and install the coin slot screw.
- Install the power/data cable.

**To adjust the universal mount...**

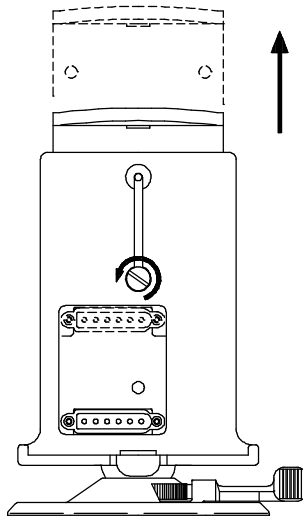

The universal mount is designed to allow the GPS 50 to be installed either with or without the battery pack attached. To adjust the universal mount to accept the GPS 50 with the battery pack attached:

- Loosen the coinslot screw.
- Raise the connector plate to its tallest position.
- Tighten the coinslot screw. When adjusted properly, the coinslot screw should fit completely into the counterbore in the cradle so that all surfaces are flush.

#### C.4 UNIVERSAL MOUNT OPERATION

The universal mount has been designed for easy insertion and removal of your GPS 50 if you wish to use the unit in another boat or vehicle, plan at home, or prevent theft.

**To insert the GPS 50 into the universal mount...**

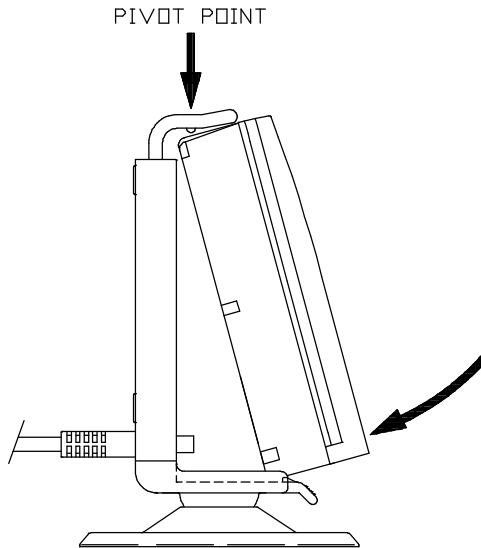

- Tilt the top of the GPS 50 into the universal mount as shown.
- Engage the slot in the top of the GPS 50 into the raised bump in the universal mount.
- Rotate the bottom of the GPS 50 into the universal mount until the unit latches securely into place.

- Connect the antenna or antenna cable. No other electrical connections are required; all power and data connections are made through the 6-pin connector installed in the universal mount.

### To remove the GPS 50 from the universal mount...

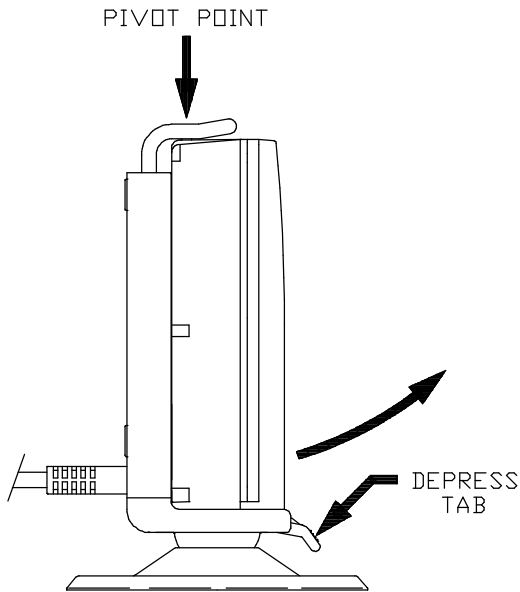

- Disconnect the antenna or antenna cable.
- Apply enough force to the release tab to allow the unit to pass as shown above.
- Pull the bottom of the GPS 50 out, then rotate the top downward and out.

### To adjust the universal mount angle...

- Loosen the mount by turning the lever counter-clockwise.
- Rotate and/or tilt the unit to the desired position.
- Tighten the lever.

## C.5 BATTERY PACK OPERATION

The GPS 50 is supplied with a sealed, 4-cell alkaline battery pack. The battery pack must be removed from the unit in order to replace the cells.

**To remove the battery pack...**

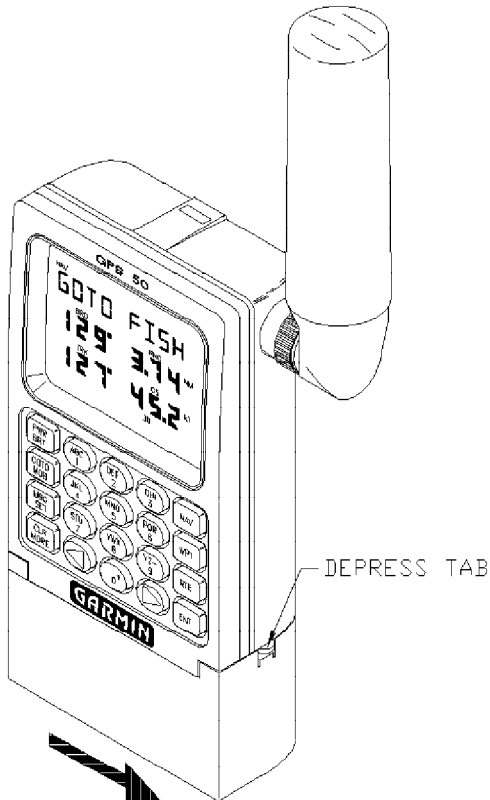

- Push down on the spring tab on the right side of the battery pack.
- Pull the battery pack off the right side of the unit.

## To replace the alkaline batteries...

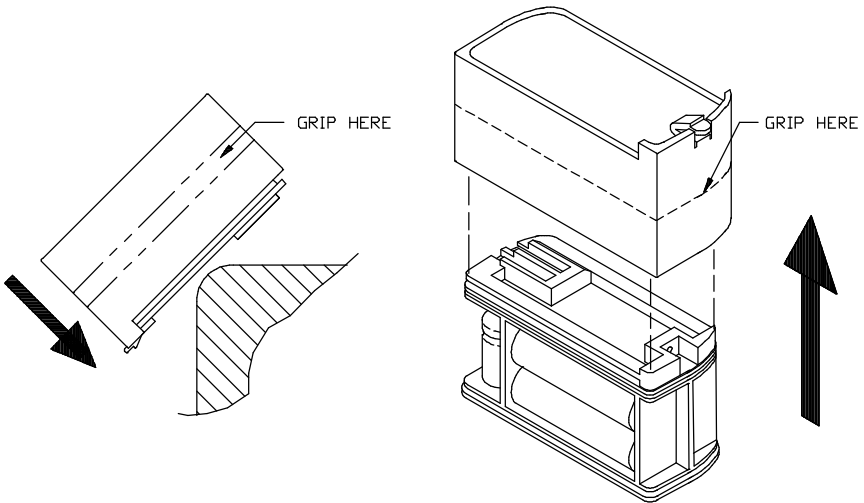

- Grip the battery pack around the outside edge (not the bottom).
- Push the top of the battery pack against the edge of a hard surface which will not mar the plastic. The outer sleeve will slide off the cage, revealing the batteries inside.
- Replace the batteries, observing the polarity diagram engraved in the plastic.
- Slide the sleeve over the cage until it snaps into place, taking care that you do not tear the gaskets which provide the battery pack seal.

## C.6 MAINTENANCE

The GPS 50 is constructed of high quality material and should not require user maintenance. Please refer any repairs to an authorized GARMIN service center. (The unit contains no user serviceable parts, do not attempt repairs yourself.)

Never allow gasoline or solvents to come into contact with your unit. Damage to the case may occur which is not covered by your warranty.

The waypoints, routes, custom settings, and other data stored in the GPS 50 are maintained by an internal battery. (These data will not be lost even if you remove the AA or rechargeable battery pack for separate storage.) The

internal memory battery should typically last three to five years. If the GPS 50 detects a low memory battery, you will be informed with the message "MEM BATT". You should return your unit to an authorized GARMIN service center as soon as possible for service. Failure to do so may result in loss of data each time you turn your unit off (indicated by the message "DATA LOST").

Your GPS 50 contains a highly accurate crystal oscillator which may drift after many years of operation. If the unit detects excessive oscillator drift, you will be informed with the message "ADJST OSC". You should return your unit to an authorized GARMIN service center as soon as possible. Failure to do so may result in degraded acquisition performance.

## **C.7 CUSTOMER SUPPORT**

Should you require additional assistance, please call our Customer Support Department. Customers in the continental United States may use our toll free number: 1-800-800-1020. Customers outside the continental United States may call 1-913-599-1515.



# APPENDIX D

## MAP DATUMS

The following is a list of the GPS 50 map datum selections and the corresponding map datum name (including the area of application):

ADINDAN	ADINDAN - Ethiopia, Mali, Senegal, Sudan
AFGOOYE	AFGOOYE - Somalia
AIN ELABD	AIN EL ABD 1970 - Bahrain Island, Saudi Arabia
ANNA1ASTR	ANNA 1 ASTRO 1965 - Cocos Islands
ARC 1950	ARC 1950 - Botswana, Lesotho, Malawi, Swaziland, Zaire, Zambia, Zimbabwe
ARC 1960	ARC 1960 - Kenya, Tanzania
ASCNSN IS	ASCENSION ISLAND 1958 - Ascension Island
ASTR BECN	ASTRO BEACON "E" - Iwo Jima Island
ASTRSOROL	ASTRO B4 SOROL ATOLL - Tern Island
ASTRO DOS	ASTRO DOS 71/4 - St. Helena Island
ASTRO STN	ASTRONOMIC STATION 1952 - Marcus Island
ASTRLN 66	AUSTRALIAN GEODETIC 1966 - Australia, Tasmania Island
ASTRLN 84	AUSTRALIAN GEODETIC 1984 - Australia, Tasmania Island
BELLEVUE	BELLEVUE (IGN) - Efate and Erromango Islands
BERMUDA	BERMUDA 1957 - Bermuda Islands
BOGOTA OB	BOGOTA OBSERVATORY - Colombia
CAMPO INC	CAMPO INCHAUSPE - Argentina
CANTON 66	CANTON ASTRO 1966 - Phoenix Islands
CAPE	CAPE - South Africa
CAP CNVRL	CAPE CANAVERAL - Florida, Bahama Islands
CARTHAGE	CARTHAGE - Tunisia
CHATHM 71	CHATHAM 1971 - Chatham Island (New Zealand)
CHUA ASTR	CHUA ASTRO - Paraguay
CREGO ALG	CORREGO ALEGRE - Brazil
DJAKARTA	DJAKARTA (BATAVIA) - Sumatra Island (Indonesia)
DOS 1968	DOS 1968 - Gizo Island (New Georgia Islands)
EASTER IS	EASTER ISLAND 1967 - Easter Island
EUROPE 50	EUROPEAN 1950 - Austria, Belgium, Denmark, Finland, France, Germany, Gibraltar, Greece, Italy, Luxembourg, Netherlands, Norway, Portugal, Spain, Sweden, Switzerland

EUROPE 79	EUROPEAN 1979 - Austria, Finland, Netherlands, Norway, Spain, Sweden, Switzerland
FIN HYFRD	FINLAND HAYFORD 1910 - Finland
GANDAJIKA	GANDAJIKA BASE - Republic of Maldives
GEOD 49	GEODETIC DATUM 1949 - New Zealand
GUAM 1963	GUAM 1963 - Guam Island
GUX ASTRO	GUX 1 ASTRO - Guadalcanal Island
HJORSY 55	HJORSEY 1955 - Iceland
HONG KONG	HONG KONG 1963 - Hong Kong
INDN TLND	INDIAN - Thailand, Vietnam
INDN BLDS	INDIAN - Bangladesh, India, Nepal
IRELND 65	IRELAND 1965 - Ireland
ISTS ASTR	ISTS O73 ASTRO 1969 - Diego Garcia
JHNSTN IS	JOHNSTON ISLAND 1961 - Johnston Island
KANDAWALA	KANDAWALA - Sri Lanka
KERGLN IS	KERGUELEN ISLAND - Kerguelen Island
KERTAU 48	KERTAU 1948 - West Malaysia, Singapore
LC5 ASTRO	L.C. 5 ASTRO - Cayman Brac Island
LIBRIA 64	LIBERIA 1964 - Liberia
LUZN PHLP	LUZON - Phillippines (excluding Mindanao Island)
LUZN MNDN	LUZON - Mindanao Island
MAHE 1971	MAHE 1971 - Mahe Island
MARCO AST	MARCO ASTRO - Salvage Islands
MASSAWA	MASSAWA - Eritrea (Ethiopia)
MERCHICH	MERCHICH - Morocco
MIDWAY 61	MIDWAY ASTRO 1961 - Midway Island
MINNA	MINNA - Nigeria
NHRN MSRH	NAHRWAN - Masirah Island (Oman)
NHRN UAE	NAHRWAN - United Arab Emirates
NHRN SADI	NAHRWAN - Saudi Arabia
NAPARIMA	NAPARIMA, BWI - Trinidad and Tobago
NAD27 CNS	NORTH AMERICAN 1927 - Mean Value (CONUS)
NAD27 ALA	NORTH AMERICAN 1927 - Alaska
NAD27 BHM	NORTH AMERICAN 1927 - Bahamas (excluding San Salvador Island)
NAD27 SSI	NORTH AMERICAN 1927 - San Salvador Island
NAD27 CAN	NORTH AMERICAN 1927 - Canada (including Newfoundland Island)
NAD27 C Z	NORTH AMERICAN 1927 - Canal Zone
NAD27 CAR	NORTH AMERICAN 1927 - Caribbean (Barbados, Caicos Islands, Cuba, Dominican Republic, Grand Cayman, Jamaica, Leeward Islands, Turks Islands)

NAD27 C A	NORTH AMERICAN 1927 - Central America (Belize, Costa Rica, El Salvador, Guatemala, Honduras, Nicaragua)
NAD27 CUB	NORTH AMERICAN 1927 - Cuba
NAD27 GRN	NORTH AMERICAN 1927 - Greenland (Hayes Peninsula)
NAD27 MEX	NORTH AMERICAN 1927 - Mexico
NAD83	NORTH AMERICAN 1983 - Alaska, Canada, Central America, CONUS, Mexico
OBSERV 66	OBSERVATORIO 1966 - Corvo and Flores Islands (Azores)
OLD EGYPT	OLD EGYPTIAN - Egypt
OLD HAWAI	OLD HAWAIIAN - Mean Value
OMAN	OMAN - Oman
GRT BT 36	ORDNANCE SURVEY OF GREAT BRITAIN 1936 - England, Isle of Man, Scotland, Shetland Islands, Wales
PICO NIEV	PICO DE LAS NIEVES - Canary Islands
PITCRN 67	PITCAIRN ASTRO 1967 - Pitcairn Island
RT90	SWEDEN
S CHILE	PROVISIONAL SOUTH CHILEAN 1963 - South Chile
S AMER 56	PROVISIONAL SOUTH AMERICAN 1956 - Bolivia, Chile, Colombia, Ecuador, Guyana, Peru, Venezuela
PURTO RIC	PUERTO RICO - Puerto Rico, Virgin Islands
QATAR NTL	QATAR NATIONAL - Qatar
QORNOQ	QORNOQ - South Greenland
REUNION	REUNION - Mascarene Island
ROME 1940	ROME 1940 - Sardinia Island
SANTO DOS	SANTO (DOS) - Espirito Santo Island
SAO BRAZ	SAO BRAZ - Sao Miguel, Santa Maria Islands (Azores)
SAPR HILL	SAPPER HILL 1943 - East Falkland Island
SCHWARZCK	SCHWARZECK - Namibia
S AMER 69	SOUTH AMERICAN 1969 - Argentina, Bolivia, Brazil, Chile, Colombia, Ecuador, Guyana, Paraguay, Peru, Venezuela, Trinidad and Tobago
S ASIA	SOUTH ASIA - Singapore
SE BASE	SOUTHEAST BASE - Porto Santo and Madeira Islands
SW BASE	SOUTHWEST BASE - Faial, Graciosa, Pico, Sao Jorge, and Terceira Islands (Azores)
TIMBLI 48	TIMBALAI 1948 - Brunei and East Malaysia (Sarawak and Sabah)
TOKYO	TOKYO - Japan, Korea, Okinawa
TRISTN 68	TRISTAN ASTRO 1968 - Tristan da Cunha

VITI LEVU	VITI LEVU 1916 - Viti Levu Island (Fiji Islands)
WAK-ENWTK	WAKE-ENIWETOK 1960 - Marshall Islands
ZANDERIJ	ZANDERIJ - Surinam
WGS 72	WORLD GEODETIC SYSTEM 1972
WGS 84	WORLD GEODETIC SYSTEM 1984

# APPENDIX E

## INDEX

<b>A</b>		Course To Steer (CTS)	B-2
Active from waypoint	6-1	Cursor	2-3
Active route	6-1	Cyclic field	2-3
Active Route Page	6-5		
Active to waypoint	6-1	<b>D</b>	
Alarm Clock Page	5-5	Data entry	2-5
Alarm Page	4-2	Date/Time Page	5-1
Alarms	4-2	Desired Track (DTK)	B-2
Alphanumeric field	2-3	Dilution of Precision (DOP)	3-1
Altitude		Display	2-1
manual entry	3-3	Distance Made Good (DMG)	B-2
units	4-4		
Anchor drag alarm	4-2	<b>E</b>	
Arrival alarm	4-2	Elapsed timer	5-2
Audio Setup Page	4-4	Estimated Position Error (EPE)	3-2
AutoStore™ Page	3-4	Estimated Time Enroute (ETE)	B-2
		Event Timer Page	5-2
<b>B</b>		<b>F</b>	
Backlighting		Field	2-3
adjusting	2-3	Filter Settings Page	4-6
timeout	4-3		
Backlighting Page	4-3	<b>G</b>	
Banners	2-1	GOTO waypoint	3-8
Battery pack		Ground Speed (GS)	B-2
AA size	1-2		
Rechargeable	1-2	<b>I</b>	
Removing	C-9	Installation	C-1
Battery Saver mode	2-6		
Bearing (BRG)	B-2	<b>K</b>	
<b>C</b>		Key press tone	2-5
CDI Page	3-4	Keypad	2-3
CDI Scale Page	4-5		
Confirmation field	2-3	<b>L</b>	
Count down timer	5-2	Local date/time	5-1
Course Made Good (CMG)	B-2		

<b>M</b>		Copying	6-5
Magnetic variation	4-5	Creating	6-3
Magnetic Variation Page	4-5	Editing active route	6-6
Maintenance	C-10	Editing storage routes	6-4
Man overboard	3-9	<b>S</b>	
Manual altitude entry	3-3	Satellite Status Page	3-1
Map datum	4-7	Searching the sky	3-1
Map Datum Page	4-7	Self test	3-1
Message banner	2-5	Setup Menu	4-1
Message Page	4-1	Simulator mode	2-6
<b>N</b>		Steer (STR)	B-2
Navigation		Sunrise/Sunset Page	5-4
2D	3-1	<b>T</b>	
3D	3-1	Time	
DR	3-1	local	5-1
Navigation Menu	5-1	UTC	5-1
Navigation units	4-4	Timers	5-2
Nearest Waypoint Page	3-7	Track (TRK)	B-2
NMEA output	4-7	Trip Planning Page	5-4
Normal mode	2-6	<b>U</b>	
Numeric field	2-3	Units Page	4-4
<b>O</b>		Universal mount	C-4
Operating mode	2-6	UTC time	5-1
Operating Mode Page	4-2	<b>V</b>	
Output, NMEA	4-7	Velocity Made Good (VMG)	B-2
Output Page	4-7	<b>W</b>	
<b>P</b>		Waypoint Definition Page	3-6
Page	2-1	Waypoints	3-5
Position Page	3-2	Wiring	C-3
Power On	3-1	<b>R</b>	
<b>R</b>		Range (RNG)	B-2
Route Catalog Page	6-2	Route Catalog Page	6-2
Route Review Page	6-3	Route Review Page	6-3
Routes		Routes	
Activating	6-5	Activating	6-5
Building with AutoStore™	6-7	Building with AutoStore™	6-7
Clearing	6-4	Clearing	6-4



**GARMIN International, Inc.**  
9875 Widmer Road  
Lenexa, KS 66215  
1-800-800-1020  
(913) 599-1515